

Takara standard

Japan, since 1912



Kitchen

Enameled Wall Panel

Enameled Washstand

System Bathroom

Shower Unit



Website

<https://www.takara-standard.co.jp/global/eng/>

The kitchen enriches my living

為生活增添豐富多彩的廚房

讓珍愛之物恆久

堅固、雅緻、潔淨
讓您愛不釋手

無須頻繁保養清潔
也能保有潔淨及愉悅的心情

The charm of enamel

01 - Tough & Clean

As dirt does not seep into the surface, a simple wipe is sufficient to clean the kitchen. Resistant to heat, shock, and scratch. Thereby its beauty will be kept longer.

污垢不會滲入，僅需擦拭便可保持潔淨。耐熱耐衝擊，不易損傷，因而能夠長久保持美觀。



02 - Healthy

Enamel, made of inorganic metal and glass, a human-friendly material containing no harmful organic substances.

琺瑯由無機物金屬與玻璃構成，不含任何有害物質，是一種對人體友善的材料。



03 - User-friendly

Magnets can provide a new storage space, allowing the wall to be decorated freely and customized for your convenience and preferences.

利用磁鐵的特性，依照自己的使用便利性及喜好，自由自在、隨心所欲地進行收納與裝飾的配置。



04 - Communication

It is possible to use oil based marking pens on the enamel panel. As their ink can be erased with a damp cloth, the wall can be used for a message board.

琺瑯材質可用油性筆書寫，且清水即能輕鬆擦拭乾淨，也可當作留言板使用。



Produced with high-grade enamel. Always clean and durable.

高品位琺瑯、經久耐用、歷久彌新、永保美觀!

Dirt resistance

耐髒污



As dirt does not seep into enamel, it is easy to clean. Oil stains around the kitchen can be wiped off quickly with a damp cloth. Seasoning or cleaners adhered to the surface will not cause discoloration or deterioration.

由於髒污不會滲入，因而保養簡便。廚房內的油污，清水便可輕輕鬆鬆擦拭去除。即使沾附上調味料和洗滌劑，也不必擔心變色、變質。

Heat resistance

耐熱



High-grade enamel is resistant to high temperatures in a place around a stove that is prone to becoming hot. Even if a fire is brought close, the surface is just soiled by soot without discoloration or deterioration.

高品位琺瑯亦適用於高溫環境的爐具周圍。即使被火燒灼，也僅僅留下煙塵，不會變色、變形。

Scratch / Shock resistance

耐衝擊，不易損傷

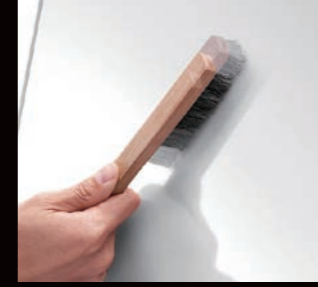

The surface will not easily become dented or scratched even if stuck with a pot or scrubbed with a stiff brush.

即使鍋具碰撞，或者用堅硬的板刷用力擦拭，也不容易出現損傷。

Safe material

安心的材質



No harmful substances such as formaldehyde that causes sick house syndrome are released. Everyone in the family can spend their time in the kitchen healthily.

不會產生可能導致病態建築症候群的甲醛等有害物質，創造確保家人健康生活的廚房空間。

The inside/outside of the kitchen cabinet are made of high-grade enamel.

廚具內外均使用高品位琺瑯



What is "high-grade enamel"?

It is a material that features both "durability of metal" and "beauty of glass".

什麼是與眾不同的“高品位琺瑯”？
兼具“鐵的堅固”和“玻璃的美觀”的材料。

Durable metal base
堅固的鐵質基材

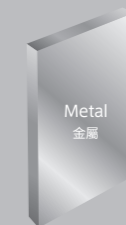

Its durability enhances shock resistance.
堅固的鐵材發揮抗衝擊的作用。

Clean glass surface
潔淨的玻璃質



Its glass layer prevents penetration of dirt and moisture.
憑藉玻璃質阻隔髒污與濕氣。

High-Grade Enamel
高品位琺瑯

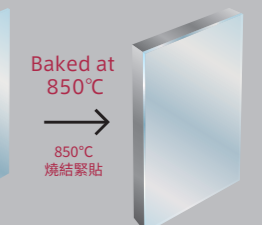

Material perfect for kitchens
形成最適於廚房的材料。

Baked at 850°C
850°C 燒結緊貼



It can store sufficient kitchen utensils and also is easy to access, allowing for efficient cooking.

“不僅容量大，而且易於取放。烹飪時的動作變得更加順手。”

Enamel Inner Tray

琺瑯製內托盤

It is convenient that even wet bowls and colanders can be stored.

碗盆濾籃濕著便可歸位，非常方便。



Hidden Enamelled Compartment

門後琺瑯刀架收納盒

By opening a little, a food wrapping film etc. can be taken out of it.

保鮮膜等只需稍稍拉開抽屜便可取出。



Front Pocket

水槽前收納盒

Perfect place to store peelers, rubber bands, and other small utensils also can fit neatly into it.

這裡非常便利。最適於削皮器及橡皮筋等小物件的完美收納區！



Enamel Inner Case

琺瑯製雙層刀叉盤

The enameled inside simplifies cleaning. Removable and washable.

琺瑯製成，保養簡便。可拆下清洗。



Easy to access when needed
The functional storage system allows for quick cooking.

想用之時能夠隨時取出！憑藉功能性收納，烹飪也變得隨心所欲。



Magnet Storage / "Anywhere" Rack
磁鐵收納/隨意架

The whole wall can be used as a storage space.
The magnet racks can be moved anywhere across
the wall after they are attached.

可使整個壁板成為收納空間，設置後也可變動。

Attaches firmly
to the wall
固定在壁板上



The combination of magnets and suckers allows firm attachment
to the wall. Even a heavy pot lid can also be held securely.
憑藉磁鐵與吸盤的雙重力量，固定在壁板上。即便是較重的鍋蓋，也不會掉落。



Recipe stand
菜譜架

Eye Level Rack
下拉收納盒

Pulled down to the eye level
only when needed.

能夠僅在使用時下拉至眼前高度



Eye Level Rack Drain Type
下拉式瀝水盤

Kitchen Series Lineup

 LEMURE



 Treasia



 Edel



When I stand here in the kitchen, I get inspired.
Ideas come to me one after another, and I feel excited.
Equipped with only features of genuine worth,
the kitchen is perfect for me.

站在這裡，靈感獲得啟發。

思路不斷湧現，心靈躍動。

這就是屬於我“真正得心應手的廚房”。





Door color: ZEBRA WOOD 櫥櫃門顏色: ZEBRA WOOD



Door color: STONE ROSE 櫥櫃門顏色: STONE ROSE





Door color: VINTAGE IRON 櫥櫃門顏色: VINTAGE IRON



Door color: FEATHER TOCHI 櫥櫃門顏色: FEATHER TOCHI



When I stand here,
my “switch” goes ON at the beginning of the day and OFF at the end.
Although I am busy every day, I try to treasure every single moment.
The kitchen “enhances my everyday life”.

平常的日子也變得非常特別

站在這裡，開啟、結束著每一天。

雖然每天都緊張匆忙，但希望珍惜地度過每一個瞬間。

早餐時間，全家人圍坐餐桌前，一起享用。

而晚餐時烹製幸福佳餚，讓餐桌上的話題變得更加豐富有趣。

使內心更加滿足而平靜，全家共同成長——

這就是我“在生活中追求的廚房”。



Door color: CONCRETE WHITE 櫥櫃門顏色: CONCRETE WHITE

Door color: ANTIQUE BRONZE 櫥櫃門顏色: ANTIQUE BRONZE



Door color: BLUE GREEN 櫥櫃門顏色: BLUE GREEN



Today I will cook one of my family's favorite meals.
The kitchen is full of sunshine pouring over the family.

舒適的感覺，是家的溫馨

站在這裡，是關愛全家人最好的位置

今天要做一頓大家都喜歡的美食。

這就是我 "充滿陽光、照耀整個家庭的廚房"。



Door color:BEIGE 櫥櫃門顏色:BEIGE



Door color:DARK BLUE 櫥櫃門顏色:DARK BLUE

Color Variations 門板顏色選擇

◎LEMURE < All 32 colors > < 32 色可選 >

Enamel System Kitchen 琺瑯系統廚房

group1 < All 20 colors > < 20 色可選 >

A variety of high-quality door color patterns are available that faithfully reproduce the texture of pottery, ceramics, marble, and others. 圖案注重材料真實質感，展現燒制的陶瓷及大理石等風韻。

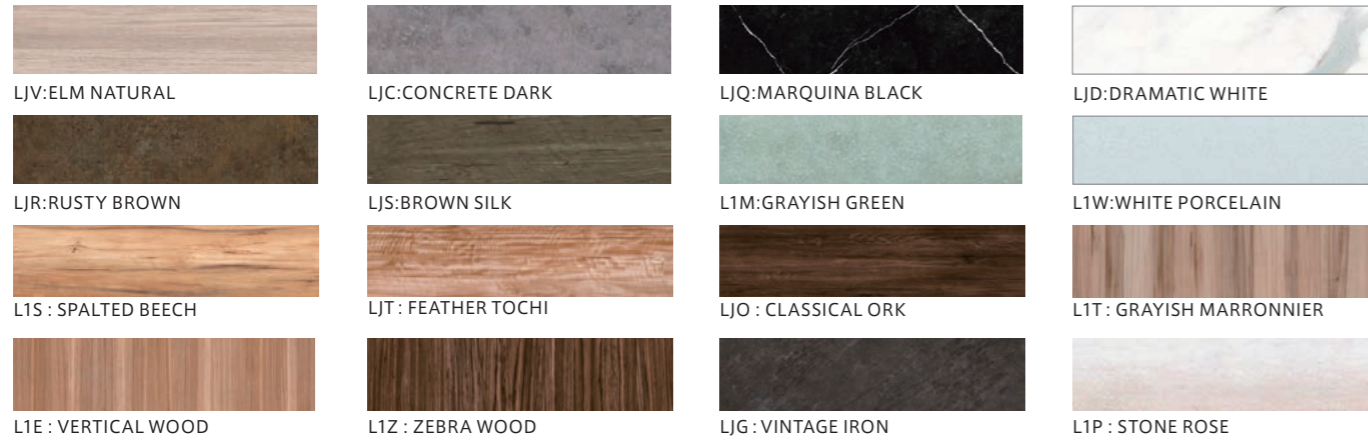

Gloss series of "deep" tone colors 呈現深色調的光澤系列

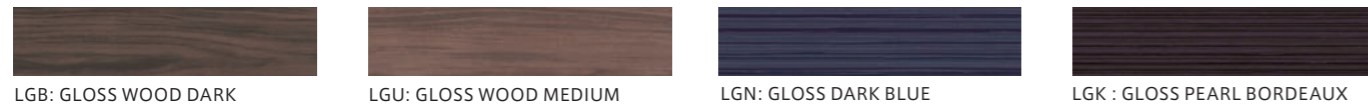

group2 < All 9 colors > < 9 色可選 >

Pearl series 珍珠系列



Clear and shiny pearl colors 華麗的珍珠光芒



Wood tone colors with soft atmosphere 柔和氣氛的原木色調



Semi-mat wood tone colors 半霧面木紋色調

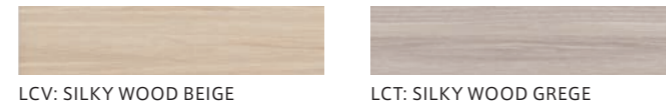

Stylish hair line patterns 時尚的細條紋

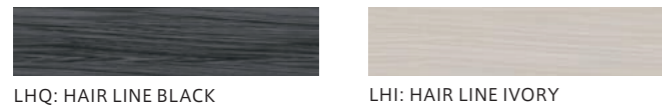

group3 < All 3 colors > < 3 色可選 >

Clear and simple color 清爽而簡潔的色彩



Door handles 把手

Rail handle 導軌拉手



Pull handle 手柄拉手



◎Treasia < All 18 colors > < 18 色可選 >

Enamel System Kitchen 琺瑯系統廚房

group1 < All 11 colors > < 11 色可選 >



group2 < All 7 colors > < 7 色可選 >

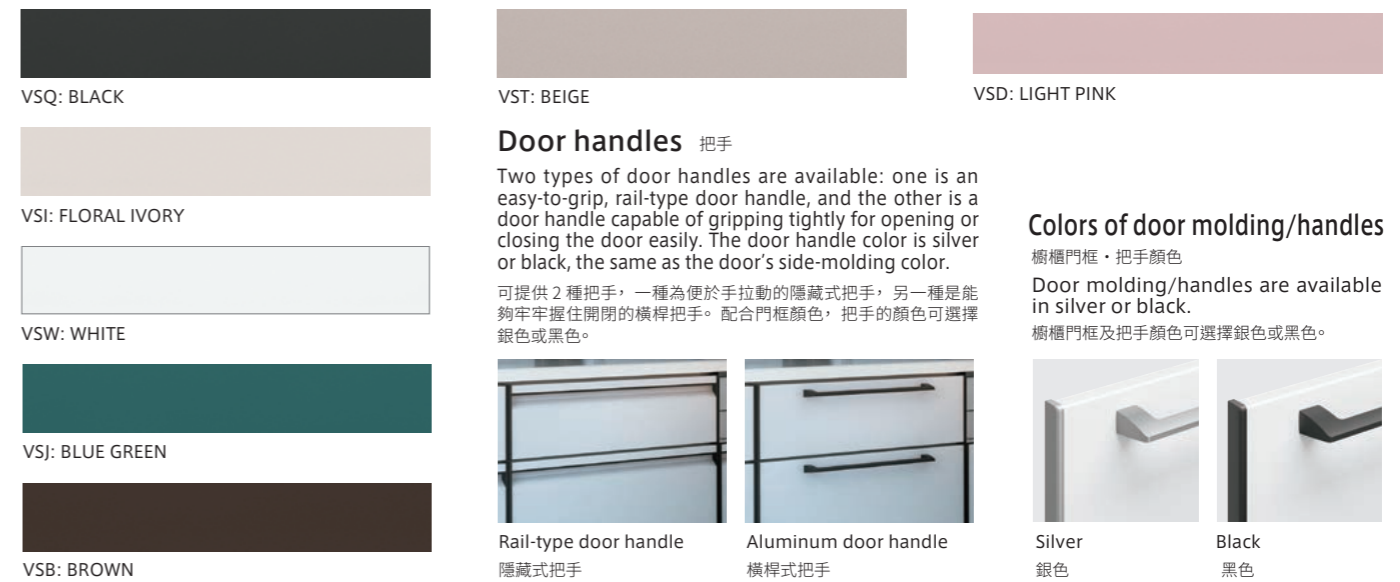

Door handles 把手

Two types of door handles are available: one is an easy-to-grip, rail-type door handle, and the other is a door handle capable of gripping tightly for opening or closing the door easily. The door handle color is silver or black, the same as the door's side-molding color.

可提供 2 種把手，一種為便於手拉動的隱藏式把手，另一種是能夠牢牢握住開閉的橫桿把手。配合門框顏色，把手的顏色可選擇銀色或黑色。



Colors of door molding/handles 櫥櫃門框·把手顏色

Door molding/handles are available in silver or black. 櫥櫃門框及把手顏色可選擇銀色或黑色。

◎Edel < All 7 colors > < 7 色可選 >

Enamel System Kitchen 琺瑯系統廚房



Cloisonné door handles are simple in design and easy-to-use. The large drawers can be pulled out easily due to the easy-to-grip handles.

簡潔的櫥櫃門設計，搭配易於使用的景泰藍把手。

Enameled Cabinet 琺瑯櫃體

◎LEMURE

Select the units you prefer
可自由挑選的櫃體

Choose from a number of easy-to-use components, combined to suit your storage needs and activities.
可依收納量和使用方法自由組合，規劃方便使用的廚房。



Soft-closing function
緩衝關閉功能



Sufficient length of drawer provides large storage space.
抽屜可拉到底，收納空間大。

Sink cabinet 水槽下櫃

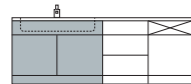

Cooking cabinet 料理台櫃

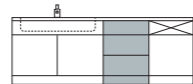

Stove cabinet 爐台櫃

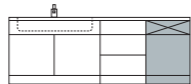

Foot-Slide type
足元抽屜款式



Foot-Slide type
足元抽屜款式



Foot-Slide type
足元抽屜款式



Slide type
抽屜款式



Slide type
抽屜款式



Type without a grill
無烤爐



Door type
開門款式



Select the right height
可供選擇的高度

Select one of four levels, to suit your own height needs.

Having the right work surfaces for your height makes long meal prep times easier.

根據身高不同，有四種廚房高度可供選擇。
配合身高的高度，可讓長時間的料理工作更加輕鬆。



Work top is not included.
不含檯面。
The type of height 86cm is only available for LEMURE.
86cm僅對應LEMURE

Select door handles
可選把手

The handles come in two types: rail handle and pull handle. These handles are excellent in usability and designability.

分為導軌拉手和手柄拉手2種。使用非常方便，並且設計極為美觀。



Rail handle

The simple and beautiful form blends in with the design.
融入設計的簡潔而美觀的樣式



Pull handle

The straight line enhances the door design.
使櫥櫃門設計更加醒目的直線樣式

L-Shape Corner Cabinet (with 65cm depth) L型轉角櫃(深度65cm型)

90cm width 寬90cm



Rotary shelves enable to access easily, offering abundant storage capacity.
容易存取的旋轉櫃
收納量也很豐富。



Wagon type

推車櫃
To make full use of the corner space of kitchen, a corner cabinet and a triangle rotary shelf are equipped. These units provide excessive space to store.
充分使用廚房角落部分的轉角櫃。也附有三角旋轉架，可多功能收納。

105cm width 寬105cm



A slide cage is mounted in the upper space and a rotary shelf in the lower space.
採用上層為拉籃，下層為旋轉板。

Option 選配件



Cabinet with Ladle/Bottle Rack

瓶罐收納櫃
Width: 15cm 寬15cm

LEMURE

Available as standard 標準配備

Enameled Compartment 門後琺瑯刀架收納盒

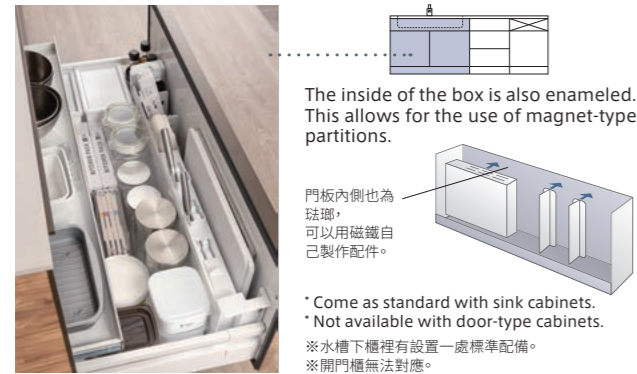

Side cover for drawer 抽屜用側蓋



Enamel rack 底部琺瑯收納架



Cabinets in black color 黑色櫥櫃顏色

The kitchen cabinets are now available in black in addition to white. Choosing black provides a sense of uniformity when coordinated with dark colors. 廚房櫥櫃除白色外，也對應黑色。使深色搭配也具有統一感。



Peripheral storage (tall unit, counter unit, and electric appliance storage unit)
周邊收納 (高櫃單元、低櫃單元、家電收納單元)



Additionally, the following units are available in black:
Electric outlet (on the kitchen and dining sides)
Touchless lighting under wall cabinet
Electric lifting wall cabinet (dish-drying type)
Steam exhaust unit, etc.

此外，插座（廚房側、餐廳側）、吊櫃下非接觸照明、電動升降吊櫃（烘乾類型）、蒸汽排放單元等對應黑色。



"Enamel Clean" area 琺瑯潔淨區域

The trash can be placed under the sink and enables smooth disposal of food scraps from cooking without water dripping from them. 對於烹飪過程中產生的廚餘垃圾，因可在水槽下設置垃圾箱，也可非常方便地進行處理，水不會滴落到地板上。

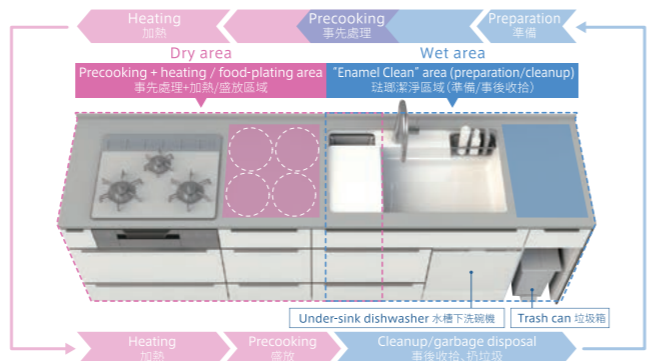
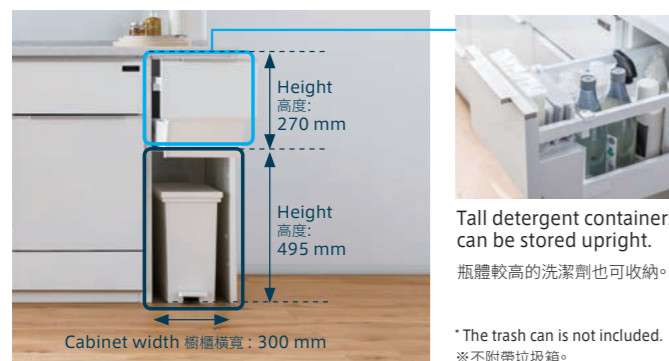

Option 選配

Enamel inner case 琺瑯製雙層刀叉盤



Enamel tray 琺瑯製內托盤



Front Pocket 水槽前收納盒



Enamel inner slide 琺瑯製內抽



Hidden enameled box 門後琺瑯刀架收納盒

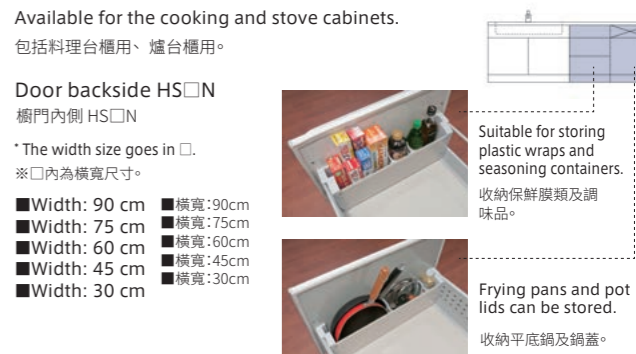

Fall prevention cover 防止掉落護板

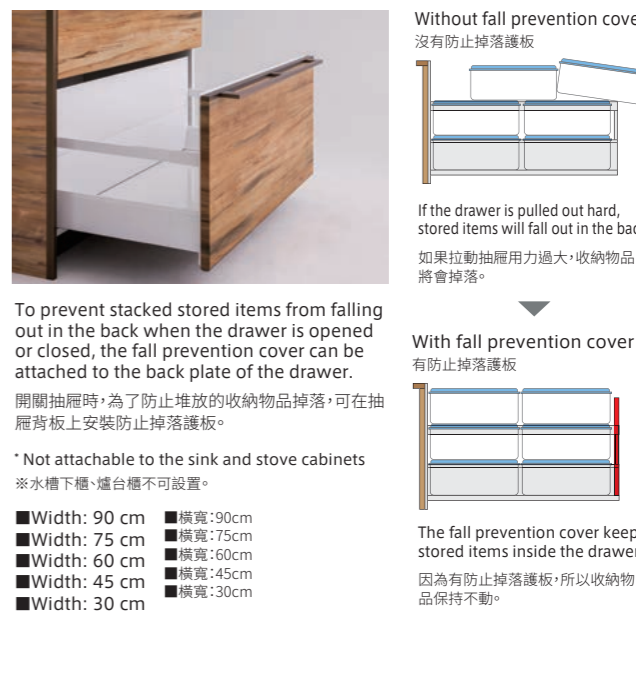

◎ LEMURE

■ Option 選配

L-shaped kitchen corner wall cabinet

L型角部用吊櫃

The corner wall cabinet consists of two parts: a long one and a short one. This eliminates dead space for storage.
L型角部用吊櫃採用長邊與短邊2分割形狀。收納時不留多餘空間。

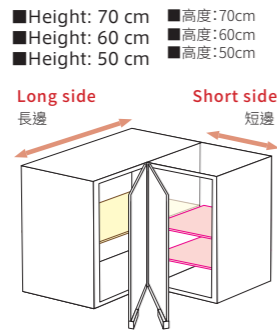

- Height: 70 cm ■ 高度: 70cm
- Height: 60 cm ■ 高度: 60cm
- Height: 50 cm ■ 高度: 50cm

Swing-up wall cabinet

上翻式吊櫃



With a single action, the door can be fully raised so that you can see all the items in storage.

只需一個動作，櫥門便整體上升，收納物品一覽無餘。

- Height: 70 cm ■ 高度: 70cm
- Width: 75 cm ■ 橫寬: 75cm
- Width: 90 cm ■ 橫寬: 90cm
- Width: 150 cm ■ 橫寬: 150cm
- Width: 165 cm ■ 橫寬: 165cm
- Width: 180 cm ■ 橫寬: 180cm

* Not installable adjacent to a corner wall cabinet for L-shaped kitchen plan
※不可以與L型角部用吊櫃相鄰設置。



Drainage cabinet type 瀝水架類型

The following three types of specifications are available.

可從下列3種規格中進行選擇。

- Without lighting
- With thin LED lighting (SMY-57LED)
- With thin touchless LED lighting (KLD-D080LW)
- 無照明規格
- 附帶薄型LED照明 (SMY-57LED) 規格
- 附帶薄型非接觸LED照明 (KLD-D080LW) 規格

- Height: 70 cm ■ 高度: 70cm
- Width: 75 cm ■ 橫寬: 75cm
- Width: 90 cm ■ 橫寬: 90cm

Wall cabinet with enamel bottom cover

底面琺瑯護板吊櫃

The wall cabinets allow you to choose enamel bottom covers that protect the cabinets from steam and heat during cooking. The enamel cover is easy to clean and stays clean.
吊櫃底面可選擇在烹飪過程中能夠保護吊櫃主體不受水蒸氣及熱量影響的琺瑯護板。



The color will be the same as the kitchen cabinet.
與櫥櫃顏色聯動。



WHITE



BLACK

Available for standard and glass doors.
對應標準櫥門、玻璃櫥門。

Kitchen wall cabinet 廚房吊櫃 Peripheral wall cabinet 周邊吊櫃

- Height: 70 cm ■ 高度: 70cm
- Height: 60 cm ■ 高度: 60cm
- Height: 50 cm ■ 高度: 50cm
- Width: 120 cm ■ 橫寬: 120cm
- Width: 90 cm ■ 橫寬: 90cm
- Width: 75 cm ■ 橫寬: 75cm
- Width: 60 cm ■ 橫寬: 60cm
- Width: 45 cm ■ 橫寬: 45cm
- Width: 30 cm ■ 橫寬: 30cm
- Height: 70 cm ■ 高度: 70cm
- Height: 60 cm ■ 高度: 60cm
- Height: 50 cm ■ 高度: 50cm
- Width: 90 cm ■ 橫寬: 90cm
- Width: 75 cm ■ 橫寬: 75cm
- Width: 60 cm ■ 橫寬: 60cm
- Width: 45 cm ■ 橫寬: 45cm

LED downlight LED筒燈

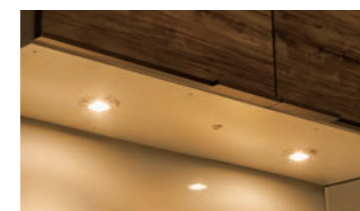

Available for enamel bottom covers for wall cabinets
對應底面琺瑯護板吊櫃。

- No. of lights: A single light for 60, 75, and 90cm-wide covers and two lights for 120cm-wide covers
- 燈泡數量: 橫寬60、75、90cm裝配1個燈泡，120cm裝配2個燈泡

Kitchen wall cabinet 廚房吊櫃 Peripheral wall cabinet 周邊吊櫃

- Height: 70 cm ■ 高度: 70cm
- Height: 60 cm ■ 高度: 60cm
- Height: 50 cm ■ 高度: 50cm
- Width: 120 cm ■ 橫寬: 120cm
- Width: 90 cm ■ 橫寬: 90cm
- Width: 75 cm ■ 橫寬: 75cm
- Color of light 燈光顏色
- Warm white 白熾燈色
- Natural white 晝白色
- Height: 70 cm ■ 高度: 70cm
- Height: 60 cm ■ 高度: 60cm
- Height: 50 cm ■ 高度: 50cm
- Width: 90 cm ■ 橫寬: 90cm
- Width: 75 cm ■ 橫寬: 75cm
- Width: 60 cm ■ 橫寬: 60cm

◎ Treasia

■ Available as standard 標準配備

Hidden Enameled Compartment

門後琺瑯刀架收納盒

Available series: Treasia
對應系列: Treasia



The inside of the box is also enameled. This allows for the use of magnet-type partitions.

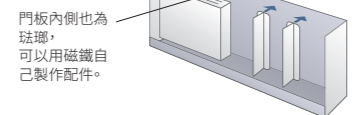

門板內側也為琺瑯，可以用磁鐵自己製作配件。

* Come as standard with sink cabinets.
* Not available with 90cm width under-sink dishwasher cabinets.

※水槽下櫃有設置一處標準配備。
※水槽下可裝設洗碗機款式之寬90cm的水槽下櫃無法對應。

■ Option 選配

Enamel tray

琺瑯製內托盤



Effective use of kitchen's empty space allows for increasing its storage capacity drastically. The enamel tray moves in and out quickly along with the drawer.

有效活用空間，大幅增加收納容量。與抽屜連結，可平順開關。

◎ Common to all series 全系列共用

L-Shape Corner Cabinet (with 65cm depth)

L型轉角櫃 (深度65cm型)

■ Available as standard 標準配備

90cm width 寬90cm



Rotary shelves enable easy access, offering abundant storage capacity.
旋轉櫃所以容易取出，收納量也很豐富。

* Edel has different specifications. ※Edel的規格不同。

105cm width 寬105cm



A slide cage is mounted in the upper space and a rotary shelf in the lower space.
採用上層為拉籃，下層為旋轉櫃。

* Edel has different specifications. ※Edel的規格不同。

■ Option 選配

Foot-Slide type (with swing-out slide basket) 足元抽屜款 (附拉籃)



Available series: Treasia
對應系列: Treasia

Large cabinets for Cooking and Stove cabinets (Foot-Slide types)

大容量櫃為料理台櫃與爐台櫃 (足元抽屜款)



Sufficient length and space
確保有寬廣的抽屜空間

Available series: Treasia
對應系列: Treasia

Cabinet with Ladle/Bottle Rack

烹飪用具、瓶子收納櫃



Available series: All series
對應系列: 全系列

Oven cabinet (Slide type)

爐台櫃抽屜型



Available series: Edel
對應系列: Edel

Two-stage Slide type with a small inner drawer inside the drawer

附櫃內抽屜兩層抽屜櫃



Available series: Edel
對應系列: Edel

Available for Edel with soft-closing function
※對應緩衝閉關規格

Tightly fitted, the adjustment fillers eliminate gaps between cabinets and walls. Width adjustment filler

消除牆壁與櫃體的縫隙，恰好符合尺寸。

尺寸調整用補板

Enameled adjustment filler fills in the spaces of base cabinets or wall cabinets. This filler makes it possible to adjust kitchen width in accordance with customer's kitchen room size. Available width size is from 2cm to 14cm by 1cm.

調整上下櫃體與牆壁之間空隙作用的補板。
補板寬度以 2cm~14cm 為限，以每 1cm 為單位可做調整；
15cm 以上可使用拉籃櫃。
使櫥櫃轉角不留縫隙，是為了防止小蟲子和灰塵侵入，進而保持櫥櫃乾淨、衛生。

Adjustment filler is not available for long type wall cabinets.

* 超長型的上櫃沒有對應的補板。

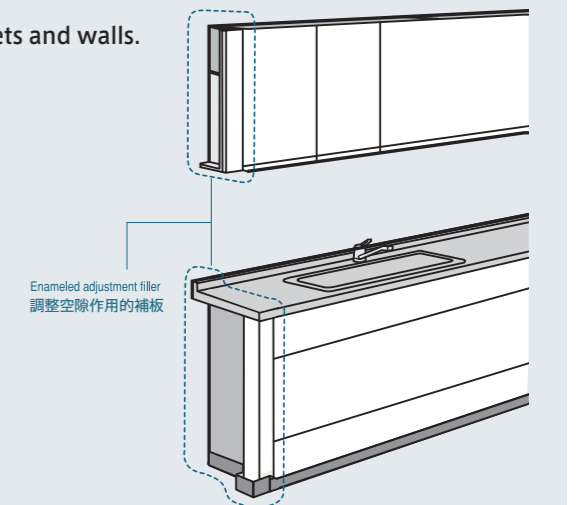

Enameled adjustment filler
調整空隙作用的補板

Stainless Steel Sink 水槽 (SUS304)

Utility Sink E type 機能型 E 水槽

Three-level sinks make washing, cooking, and tidying-up easier.
三層式水槽使「清洗、烹調、收拾」得心應手。

* Not available with 60cm depth cabinets.
※深度60cm型無法對應。

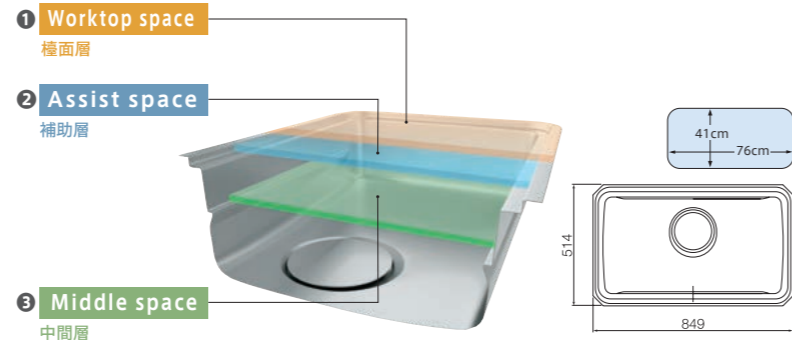

Placing the chopping board makes it easy to cut hard vegetables by applying more force on them.

放置砧板在這個高度的話，切較硬的蔬菜時會比較容易出力。



Rinse boiled pasta right into the sink. No worries about stains. Kitchen work stays neat and clean.

傾倒煮義大利麵的熱水時，不用擔心弄髒水槽，非常乾淨。

Three levels with different characteristics make various tasks more comfortable.
利用特徵不同的三個空間，使各式各樣的烹調更輕鬆。

1 Increased work space 擴大做菜空間

Worktop space 檯面層

Option 選配



SK Drainage Board USE
SK 瀝水盤 USE

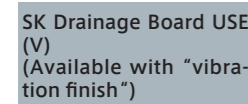

SK Drainage Board USE (V)
(Available with "vibration finish")
耐刮痕加工 SK 瀝水盤 USE (V)

2 Improved work efficiency 提高工作效率

Assist space 補助層

Option 選配



Chopping Board USE
砧板 USE



Chopping board USE-H (synthetic rubber)
砧板 USE-H (合成塑膠材料)

The impact of the knife blade is soft, dry quickly, and hygienic. Not only does it have a good contact with the knife, but it is also easy to clean and very hygienic.



Drainage Rack USE
滴水架 USE
A foldable and compact drainage net for drying a large dish and pot easily. It is suitable for drying large plates and pots. After folding, it can be easily stored.



Kitchen waste pocket USE
垃圾收集網籃 USE

3 Efficient use of middle space 有效利用水槽的中間層

Middle space 中間層

Option 選配

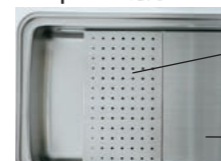

Middle-Space Drainage Board USE
中間瀝水盤 USE



Middle-Space Cooking Board USE
中間料理用盤 USE

* The boards with "vibration finish" have (V) at the end of their product number.
※耐刮痕加工品會在品號尾碼加上 (V)。

Able to install in assist space and middle space

可設置在補助層與中間層



Drainage net USE (A)
瀝水籃 USE (A)



Detergent Rack USE
洗潔劑籃 USE



The installed dispenser will not interfere with the sliding of the plate.
中層的附屬配件即便移動上層，配板也不會發生碰撞。

Other options 其他選配



SK Detergent Rack
SK 清潔劑籃



SK Board Stand
SK 水槽配板立架



Water Stopper V
止水蓋 V



Water Stopper
止水蓋

Stainless Steel Sink 不鏽鋼水槽

Raku-L sink 樂L水槽

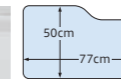

Optional accessories for User-Friendly L Sinks [樂L水槽專用選配]



The drainage board can be placed upside down. This allows you to put a chopping board on it, thus expanding the cooking space.
翻過控水架，上面可擺置砧板，擴大操作空間。

1 You CAN customize the sink the way you want it.

① 可隨心所欲搭配使用！

A small-item holder or other accessories can be hooked to the L-shaped bar.



2 You CAN wash even a large frying pan with ease.

② 較大的平底鍋也可輕鬆清洗！



3 With the L-shaped bar, you can EASE your dish washing routine.

③ L型桿使家務事變得輕鬆！

The small-item holder can slide aside, allowing you to clean the sink easily. The L-shaped bar is detachable and easy to clean.

可改變雜物架的位置，輕鬆地進行清洗。L型桿可取下，方便進行清洗保養。

4 You CAN keep the sink clean.

④ 保持清潔



Z Sink Z水槽



Z-sink options 專用選配



Drainage Board Z (stainless steel)
瀝水盤 Z (不鏽鋼製)



Drainage Board ZT (stainless steel)
瀝水盤 ZT (不鏽鋼製)



Chopping Board Z
砧板 Z

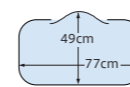

Small Utensil Holder
小物籃
Available as standard
標準配備



Drainage Rack ZS
瀝水籃 ZS



Chopping Board Stand Z (B)
砧板立架 Z (B)

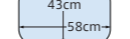

SK Board Stand
SK 水槽配板立架

ZM-sink/ZS-sink options 專用選配



Drainage Board ZS (stainless steel)
瀝水盤 ZS (不鏽鋼製)



Drainage Rack ZS
瀝水籃 ZS

Options available with Z, ZM and ZS sinks Z·ZM·ZS共通選配



Water Stopper V
止水蓋 V



Water Stopper
止水蓋

Y Sink Y水槽

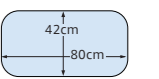

Y-sink options 專用選配



SK Drainage Board TI (Available with stainless steel worktops)
SK 瀝水盤 TI (對應不鏽鋼檯面)



Drainage Rack N (S)
瀝水籃 N
* Can also be used with S sinks.
※也可對應 S 水槽。

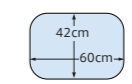

Drainage Rack S (S)
瀝水籃 S (S)



SK Board Stand
SK 水槽配板立架

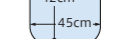

Water Stopper
止水蓋



Water Stopper
止水蓋

Options available with Y, S and F sinks Y·S·F共通選配



Water Stopper V
止水蓋 V



Water Stopper
止水蓋

Enameled Kitchen Panel 琺瑯廚房壁板

Enamel is the most suitable material for kitchen equipment.

琺瑯是廚房設備最理想的材質



The base of the Kitchen Panel is made of metal and magnets can be attached. Various kinds of small magnet items convenient to be attached to the high-grade porcelain enamel are available.

底材為金屬，可使用磁鐵附件。

在此為您準備了各式各樣的便利磁吸小物，可以吸附在高品質的琺瑯上。



Benefit 特點



The hard and smooth surface allows smear to be quickly wiped off, thus ensuring everlasting cleanliness.

表面堅硬平滑可輕易擦拭髒污，清潔容易。



Enamel is not damaged even by scrubbing wire brush.

使用鋼刷刷洗，琺瑯也不會受損。



Enamel does not fade or change in color even if exposed to high temperatures.

即使經受高溫，琺瑯也不會褪色或變色。

HD Wood grain HD木紋模樣

Reproduces natural wood grain patterns faithfully. 完整呈現天然木材的木紋。



QKW:ELM WHITE



QKG:ELM GREGE

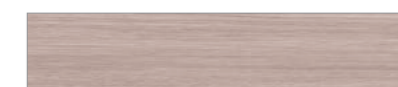

QKV:ELM NATURAL

HD 石目 HD石目

These panels use a trendy Marquina marble pattern as a motif. 時尚的黑白跟大理石紋理主題。



QEV:MARQUINA BEIGE



QEG:MARQUINA GRAY



QEQ:MARQUINA BLACK



QDI:OYA TUFF STONE

HD Concrete HD水泥

These panels offers a concrete look that is now trending in the interior design. 時尚的混凝土內裝風格。



QCG:CONCRETE GRAY



QCQ:CONCRETE DARK

HD Marble HD大理石模樣

Reproduces the marble patterns used for luxury hotels and buildings. 重現使用於高級飯店及大樓的大理石紋路。

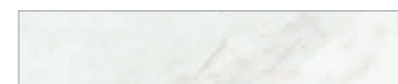

IDW:DRAMATIC WHITE

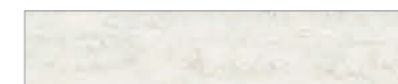

QTW:TRAVERTINE WHITE



QTV:TRAVERTINE BEIGE

* As the patterns of panels are designed to imitate those of genuine marble stones, the color shades may vary depending on the panels.
※大理石模樣的壁板是模仿實際的石頭，所以顏色可能依壁板而有所差異。

HD Art HD藝術

Line-up of beautiful designs that colors kitchens. 裝飾美麗廚房的藝術風系列。



IMV:MOSAIC BEIGE



IMG:MOSAIC GRAY



IAG:EMBOSS TILE

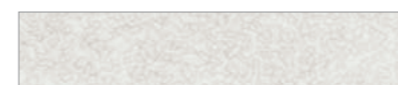

QYW:WHITE PORCELAIN

Simple colors Simple colors

Simple colors make it easier to coordinate with your interior. 容易搭配室內裝潢的簡樸色調。



DWH:STONE WHITE



YWH:WOOD MILD WHITE



PW:PEARL WHITE

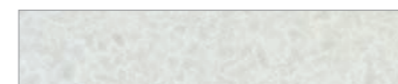

MGN:MARBLE GRAY



MBN:MARBLE BEIGE

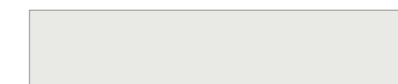

SW:WHITE



PIN:PURE IVORY

Range hood 抽油煙機



Enamel Clean Range Hood 珐瑯清潔抽油煙機

Components prone to stains are enameled. Easy to clean!

容易變髒的部分採用珐瑯，讓保養變得非常簡單！

Which components of the range hood are prone to oil stains? How prone is each such component to oil stains?

抽油煙機容易粘附油污的部位及比例

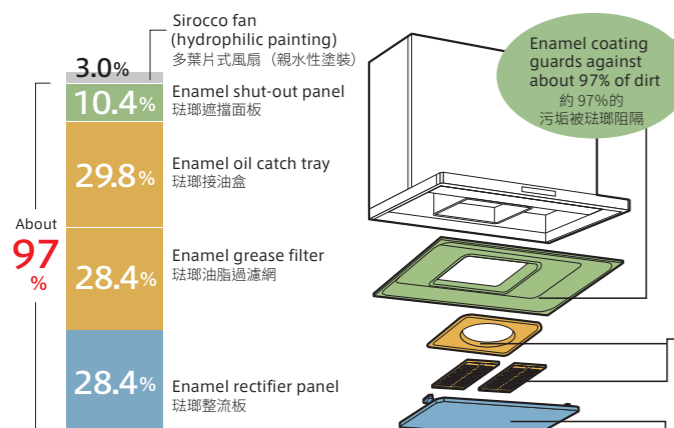

The figures given above are based on our in-house testing: Calculations were made using the experimental data obtained by measuring the amount of oil collected from each component that requires cleaning.

The total amount of oil produced was about 140g. Of that total, there was about 75g of oil collected from the surfaces of components that required cleaning. The percentages given above are based on 75g of oil.

本公司調查：根據不同保養部位油污採集實驗數據計算得出。
※產生的約140g油污之中，需要對吸排油煙機進行保養的部分上粘附的約75g油污之中的比例。

Furthermore 並且

Sirocco fan 多葉片式風扇

Hydrophilic and easy to clean dirt with water. Easily detachable with one touch!

採用水即可去除油污的親水性風扇。只需一按便可取下，操作簡便！



*The photos, illustrations, and values shown above are for VRAS type.
※照片、插圖及數值等為 VRAS 型。

Super Triple Guard 超級三重阻隔

Enamel shut-out panel 珐瑯遮擋面板

Prevents dirt from getting inside. Cleanable with a damp cloth when dirty.

遮擋污垢進入內部。即使出現髒污，用水擦拭即可潔淨如新。



The corners are free of joint gaps and easy to wipe clean. 彎角部也沒有縫隙，形狀易於擦拭。

Enamel grease filter / Enamel oil catch tray 珐瑯油脂過濾網·珐瑯接油盒

One-touch detachable, washable easily in a dishwasher.

輕輕一按便可取下，可用洗碗機輕鬆清洗。

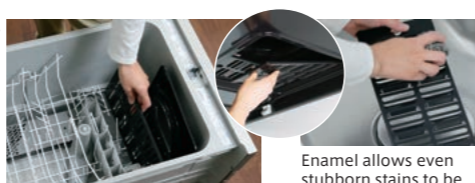

*If darkened, clean it with cleanser. 因為是珐瑯，頑固的污垢也可用力擦拭清洗。
※附著上黑斑之時，請用去污粉擦除。

Enamel rectifier panel 珐瑯整流板

Able to clean oil stains by wiping with a damp cloth. 油污也只需用水擦拭便可去除乾淨。



Designed to create an air flow to suck the smoke easily. 產生空氣流動，容易吸入油煙的設計。

Sirocco fan (exhaust fan) 多葉片式風扇 (排氣型)

Enamel Clean Range Hood 珐瑯清潔抽油煙機



Takara's original products Takara 獨創

Super triple guard 超級三重阻隔				機控開關	LED 照明	Operates in synch with stove 加熱器連動
Enamel shut-out panel 珐瑯遮擋面板	Enamel grease filter 珐瑯油脂過濾網	Enamel oil catch tray 珐瑯接油盒	Enamel rectifier panel 珐瑯整流板	Hydrophilic, one-touch detachable fan 輕輕一按便可取下的親水性風扇	Touch switch 保養提示 Cleaning indicator 延時計時器	

Front panel: Stainless steel / able to coordinate the front panel color with the (enameled) doors.

前飾板:有兩種可選銀色不銹鋼與櫥櫃門板顏色(珐瑯)。



Front panel / Hood part: stainless steel 前飾板·排煙罩部:不銹鋼

VRAS-E■2AD L/R(S)

VRAT type VRAT型



Takara's original products Takara 獨創

Super triple guard 超級三重阻隔				軟觸按鍵	Operates in synch with stove 加熱器連動
Enamel shut-out panel 珐瑯遮擋面板	Enamel grease filter 珐瑯油脂過濾網	Enamel oil catch tray 珐瑯接油盒	Enamel rectifier panel 珐瑯整流板	soft-push switch LED 照明	

Able to coordinate the front panel color with the (enamel) doors. 可與櫥櫃門顏色(珐瑯)搭配。



Hood part Color: silver 排煙罩部顏色:銀色

Able to coordinate the front panel color with the (enamel) doors. 可與櫥櫃門顏色(珐瑯)搭配。

Hood part: black 排煙罩部顏色:黑色

VRAT-■2AD L/R(V/K)

Front panel / Hood part: silver 前飾板·排煙罩部:銀色



Front panel / Hood part: black 前飾板·排煙罩部:黑色



VRAT-■2AD L/R(V/K)



“Mount Anywhere” Magnet Racks | Square type 隨意架 | 方型

Towel Hanger 毛巾架

<p>■ Towel Hanger S 毛巾架S</p>  <p>MGSK Towel Hanger S (■) MGSK毛巾架S (■) (150×60×50mm) Maximum load: 500g 最大載重: 500g</p>	<p>■ Towel Hanger L 毛巾架L</p>  <p>MGSK Towel Hanger L (■) MGSK毛巾架L (■) (350×60×50mm) Maximum load: 500g 最大載重: 500g</p>	<p>■ Multi-Rack +Towel Hanger 多用途收納架+毛巾架</p>  <p>MGAK Small Utensil Tray Rack 15S (W) + MGSK Towel Hanger L (■) MGAK小物收納架15S (W) + MGSK毛巾架L (■) (350×60×120mm) Maximum load: 1.5kg 最大載重: 1.5kg</p>	<p>■ Small Utensil Rack S +Hook + Towel Hanger 小物收納架S+掛鉤+毛巾架</p>  <p>MGAK Small Utensil Tray 15S (W) + MGAK Hook S (W) + MGSK Towel Hanger L (■) MGAK小物收納架15S (W) + MGAK掛鉤S (W) + MGSK毛巾架L (■) (350×60×80mm) Maximum load: 1.5kg 最大載重: 1.5kg</p>
------------------------------------------------------------------------------------------------------------------------------------------------------------------------------------------------------------------------------------------	------------------------------------------------------------------------------------------------------------------------------------------------------------------------------------------------------------------------------------------	-----------------------------------------------------------------------------------------------------------------------------------------------------------------------------------------------------------------------------------------------------------------------------------------------------------------------	-----------------------------------------------------------------------------------------------------------------------------------------------------------------------------------------------------------------------------------------------------------------------------------------------------------------------------------------------------------------------

<p>■ Multi-Rack +Hook + Towel Hanger 多用途收納架+掛鉤+毛巾架</p>  <p>MGAK Small Utensil Tray 15S (W) + MGAK Hook S (W) + MGSK Towel Hanger L (■) MGAK小物收納架15S (W) + MGAK掛鉤S (W) + MGSK毛巾架L (■) (350×60×140mm) Maximum load: 1.5kg 最大載重: 1.5kg</p>	<p>■ Swing towel hanger 伸縮毛巾架</p>  <p>MGSK swing towel hanger (■) MGSK伸縮毛巾架 (■) (195×37×36mm) Maximum load: 400g 最大載重: 400g</p>	 <p>The arm can swing in and out so that the door can be pulled out with a single action. 伸縮架可調整,因而一次操作便可拉開櫥門。</p>
------------------------------------------------------------------------------------------------------------------------------------------------------------------------------------------------------------------------------------------------------------------------------------------------------------------------------------------------------------	----------------------------------------------------------------------------------------------------------------------------------------------------------------------------------------------------------------------------------------------------	----------------------------------------------------------------------------------------------------------------------------------------------------------------------------------------------------------

Small Utensil Rack 小物收納架

<p>■ Small Utensil Rack S 小物收納架S</p>  <p>MGAK Small Utensil Tray 15S (W) + MGSK Towel Hanger L (■) MGAK小物收納架15S (W) + MGSK毛巾架L (■) (150×60×55mm) Maximum load: 1kg 最大載重: 1kg</p>	<p>■ Small Utensil Rack M 小物收納架M</p>  <p>MGSK Small Utensil Rack (■) MGSK小物收納架 (■) (150×95×55mm) Maximum load: 1kg 最大載重: 1kg</p>	<p>■ Small Utensil Rack L 小物收納架L</p>  <p>MGAK Small Utensil Tray 35S (W) + MGSK Towel Hanger L (■) MGAK小物收納架35S (W) + MGSK毛巾架L (■) (350×60×55mm) Maximum load: 1.5kg 最大載重: 1.5kg</p>	<p>■ Small Utensil Rack S+ Hook 小物收納架S+掛鉤</p>  <p>MGSK Small Utensil Hook S (■) MGSK小物掛鉤S (■) (150×60×80mm) Maximum load: 1kg 最大載重: 1kg</p>	<p>■ Small Utensil Rack L+ Hook 小物收納架L+掛鉤</p>  <p>MGSK Small Utensil Hook L (■) MGSK小物掛鉤L (■) (350×60×80mm) Maximum load: 1.5kg 最大載重: 1.5kg</p>	<p>■ Multi-Rack 多用途收納架</p>  <p>MGSK Small Utensil Holder (■) MGSK小物收納架 (■) (150×60×120mm) Maximum load: 1kg 最大載重: 1kg</p>	<p>■ Multi-Rack + Hook 多用途收納架+掛鉤</p>  <p>MGSK Small Utensil Holder (■) + MGAK Hook S(W) MGAK小物收納架 (■) + MGAK掛鉤S (W) (150×60×140mm) Maximum load: 1kg 最大載重: 1kg</p>
------------------------------------------------------------------------------------------------------------------------------------------------------------------------------------------------------------------------------------------------------------------------------------------------------	------------------------------------------------------------------------------------------------------------------------------------------------------------------------------------------------------------------------------------------------------	----------------------------------------------------------------------------------------------------------------------------------------------------------------------------------------------------------------------------------------------------------------------------------------------------------	-----------------------------------------------------------------------------------------------------------------------------------------------------------------------------------------------------------------------------------------------------------------	----------------------------------------------------------------------------------------------------------------------------------------------------------------------------------------------------------------------------------------------------------------------	-------------------------------------------------------------------------------------------------------------------------------------------------------------------------------------------------------------------------------------------------	------------------------------------------------------------------------------------------------------------------------------------------------------------------------------------------------------------------------------------------------------------------------------------------

Multi-Rack 多用途收納架

Multi-Holder 多用途掛架

<p>■ Multi-Holder 多用途掛架</p>  <p>MGSK Multi-Holder (■) MGSK多用途掛架 (■) (150×95×75mm) Maximum load: 1kg 最大載重: 1kg</p>	<p>■ Towel Hanger 抹布架</p>  <p>MGSK Towel Hanger (W) MGSK抹布架 (W) (265×20×160mm) Maximum load: 200g/pc 最大載重: 平均一根 200g</p>	<p>■ Kitchen Paper Holder 餐巾紙架</p>  <p>MGSK Paper Holder (W) MGSK餐巾紙架 (W) (270×85×45mm) Maximum load: 250g 最大載重: 250g</p>
----------------------------------------------------------------------------------------------------------------------------------------------------------------------------------------------------------------------------------------	-----------------------------------------------------------------------------------------------------------------------------------------------------------------------------------------------------------------------------------------------	------------------------------------------------------------------------------------------------------------------------------------------------------------------------------------------------------------------------------------------------

Available in two colors.
有兩種顏色可供選擇。



CG: Charcoal gray W: White

* The color number is provided in the black box (■) at the end of each product number. Each product is available in two colors: CG (Charcoal Gray) and W (White).
※品號的■是顏色品號,分別有CG:暗灰色和W:白色,兩種顏色可供選擇。

“Mount Anywhere” Magnet Racks 隨意架

<p>■ Ladle Holder 烹飪用具掛架</p>  <p>MGSK Ladle Hanger (W) MGSK烹飪用具掛架 (W) (255×39×30mm) Maximum load: 300g per hook 最大載重: 掛鉤平均一個 300g</p>	<p>■ Pot Lid Holder 鍋蓋架</p>  <p>MGSK Pot Lid Holder (W) MGSK鍋蓋架 (W) (255×142×222mm) Maximum load: 1.5kg 最大載重: 1.5kg</p>	<p>■ Free Rack 任意架</p>  <p>MGSK Free Rack (W) MGSK任意架 (W) (390×150×88mm) Maximum load: 1.5kg 最大載重: 1.5kg</p>	<p>■ Recipe Stand 食譜架</p>  <p>MGSK Recipe Stand (W) MGSK食譜架 (W) (255×80×74mm) Maximum load: 1.5kg 最大載重: 1.5kg</p>	<p>■ Chopping Board Stand 砧板立架</p>  <p>MGSK Chopping Board Stand (W) MGSK砧板立架 (W) (255×75×74mm) Maximum load: 1.8kg 最大載重: 1.8kg</p>	<p>■ Towel Hanger (Top surface mounting type) 抹布架(上面安裝款式)</p>  <p>MGSK Towel Hanger (W) MGSK上面抹布架 (W) (155×322×26mm) Maximum load: 200g/pc 最大載重: 平均一根 200g</p>	<p>■ Spice Holder 調味料架</p>  <p>(94×113×90mm) Spice Holder T (W) 調味料架T (W)</p>
------------------------------------------------------------------------------------------------------------------------------------------------------------------------------------------------------------------------------------------------------------	----------------------------------------------------------------------------------------------------------------------------------------------------------------------------------------------------------------------------------------------	-----------------------------------------------------------------------------------------------------------------------------------------------------------------------------------------------------------------------------------	----------------------------------------------------------------------------------------------------------------------------------------------------------------------------------------------------------------------------------------	-----------------------------------------------------------------------------------------------------------------------------------------------------------------------------------------------------------------------------------------------------------	---------------------------------------------------------------------------------------------------------------------------------------------------------------------------------------------------------------------------------------------------------------------------------------	----------------------------------------------------------------------------------------------------------------------------------------------------------------------------------------------

“Mount Anywhere” Magnet Rack | Deluxe Type 隨意架 | 豪華型

Aluminum type 鋁材質

<p>■ Small Utensil Rack 小物收納架</p>  <p>MGD-KR (V) (290×111×71mm) Maximum load: 1.5kg 最大載重: 1.5kg</p>	<p>■ Ladle Hanger 烹飪用具掛架</p>  <p>MGD-KH (V) (290×14×52mm) Maximum load: 300g per hook 最大載重: 掛鉤平均一個300g</p>	<p>■ Towel Hanger 抹布架</p>  <p>MGD-FH (V) (262×14×71mm) Maximum load: 200g/pc 最大載重: 平均一根 200g</p>
----------------------------------------------------------------------------------------------------------------------------------------------------------------------------------------------------------------------	-----------------------------------------------------------------------------------------------------------------------------------------------------------------------------------------------------------------------------	-------------------------------------------------------------------------------------------------------------------------------------------------------------------------------------------------------------------

Aluminum enamel type 鍍鋁琺瑯

<p>■ Small Utensil Rack 小物收納架</p>  <p>MGH-KR (W) (290×111×71mm) Maximum load: 1.5kg 最大載重: 1.5kg</p>	<p>■ Ladle Hanger 烹飪用具掛架</p>  <p>MGH-KH (W) (290×14×52mm) Maximum load: 300g per hook 最大載重: 掛鉤平均一個300g</p>	<p>■ Towel Hanger 抹布架</p>  <p>MGH-FH (W) (262×14×71mm) Maximum load: 200g/pc 最大載重: 平均一根 200g</p>
----------------------------------------------------------------------------------------------------------------------------------------------------------------------------------------------------------------------	-----------------------------------------------------------------------------------------------------------------------------------------------------------------------------------------------------------------------------	-------------------------------------------------------------------------------------------------------------------------------------------------------------------------------------------------------------------

Eye Level Rack 下拉收納盒

System Lifting Rack “Eye Level Rack” 升降拉籃「下拉收納盒」

Eye Level Rack for LEMURE · Treasia LEMURE與Treasia專用下拉收納盒



- For 30cm width 使用寬度為30cm
- For 45cm width 使用寬度為45cm
- For 60cm width 使用寬度為60cm
- For a type with LED lighting 附有LED照明款式
- For 75cm width 使用寬度為75cm
- For a type with LED lighting 附有LED照明款式
- * Maximum load: 3kg (For 75cm: 4kg)
※最大載重為3kg (For 75cm為4kg)

Eye Level Rack for Edel Edel專用下拉收納盒



- For 30cm width 使用寬度為30cm
- For 45cm width 使用寬度為45cm
- For 60cm width 使用寬度為60cm
- For a type with LED lighting 附有LED照明款式
- For 75cm width 使用寬度為75cm
- For a type with LED lighting 附有LED照明款式
- * Maximum load: 3kg (For 75cm: 4kg)
※最大載重為3kg (For 75cm為4kg)

Eye Level Rack for LEMURE · Treasia (L type) LEMURE與Treasia專用下拉收納盒 (L型)



- For 30cm width 使用寬度為30cm
- For 45cm width 使用寬度為45cm
- For 60cm width 使用寬度為60cm
- * Maximum load: 3kg
※最大載重為3kg

Eye Level Rack for Edel (L type) Edel專用下拉收納盒 (L型)



- Tall utensils can be stored. 也可收納高度高的物品。
- For 30cm width 使用寬度為30cm
- For 45cm width 使用寬度為45cm
- For 60cm width 使用寬度為60cm
- * Maximum load: 3kg
※最大載重為3kg

Eye Level Rack Drain Type for LEMURE · Treasia LEMURE與Treasia專用下拉式瀝水盤



LED type LED款式

- For 75cm width 使用寬度為75cm
- For 90cm width 使用寬度為90cm
- * Maximum load: 10kg
※最大載重為10kg

Eye Level Rack Drain Type for Edel Edel專用下拉式瀝水盤



LED type LED款式

- For 75cm width 使用寬度為75cm
- For 90cm width 使用寬度為90cm
- * Maximum load: 10kg
※最大載重為10kg

Lifting Rack 油壓升降拉籃



- for 90cm front width 使用寬度為90cm
- for 60cm front width 使用寬度為60cm

Enameled Wall Panel

Enameled walls panels allow the interior to remain a beautiful and cozy living space for many years to come.
任何時候均保持美觀和樂趣的琺瑯內裝壁板。

Emawall



Color Variations 門板顏色選擇

The color variations are available in all 29 colors.

29種顏色變化可供選擇。

Wood grain 木紋模樣

Direction of pattern: selectable from horizontal or vertical wood grain

紋路方向：可選擇縱木紋或橫木紋



QSW : WALNUT IVORY



ISU: WALNUT MEDIUM



INB: WALNUT BROWN



QOV: OAK NATURAL



QKW: ELM WHITE



QKV: ELM NATURAL

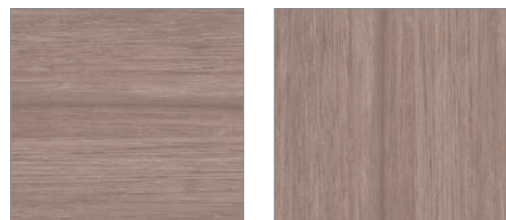

QKG: ELM GREGE

Panels are mountable horizontally or vertically.

面板為縱向設置或橫向設置任一種皆可對應。

Vertical mounting
縱向設置

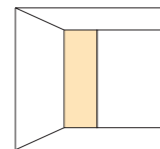

Horizontal mounting
橫向設置

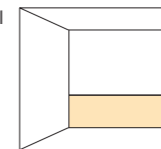

Pearl / Solid 粉色模樣·素面

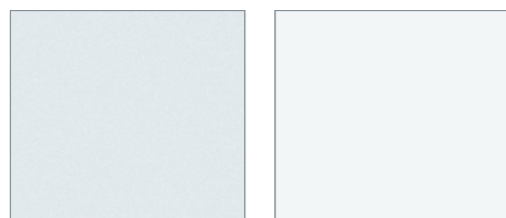

PW: PEARL WHITE

SW: WHITE

Panel structure 面板結構

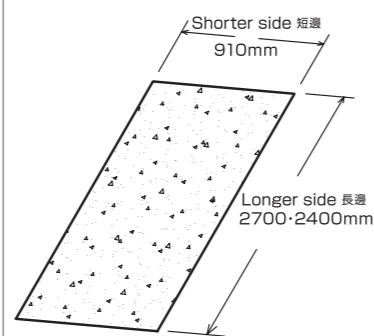

Specification 規格		
Flat type (P) 平面型 (P)		
Size 尺寸	910 mm × 2700 mm	910 mm × 2400 mm
Weight 重量	about 19kg 約 19kg	about 17kg 約 17kg
Thickness 厚度	Enameled steel with 1.3mm thickness 1.3mm 鋼板琺瑯	

Direct Clear Process Direct Clear (簡潔) 手法

Clearer images and bigger patterns can be used, thanks to the Direct Clear Process. Patterns are printed directly on the surfaces.

利用直接噴吹花紋的Direct Clear (簡潔) 手法，實現高精確度的表現和大的圖案。

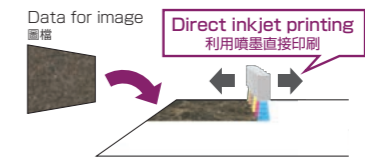

Image is printed directly onto the enameled surface.
從圖檔直接印刷至琺瑯。

Marble grain 石紋模樣

Direction of pattern: selectable from horizontal or vertical marble grain

紋路方向：可選擇縱石紋或橫石紋



QGW: GEO MARBLE WHITE



QGV: GEO MARBLE BEIGE



QGG: GEO MARBLE GRAY

Marble grain 石紋風格

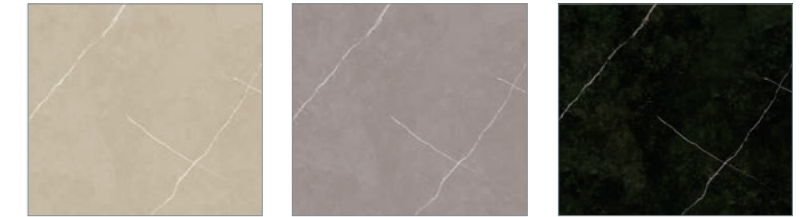

QEV: MARQUINA BEIGE

QEG: MARQUINA GRAY

QEQ: MARQUINA BLACK



QTW: TRAVERTINE WHITE

QTV: TRAVERTINE BEIGE

IDW: DRAMATIC WHITE

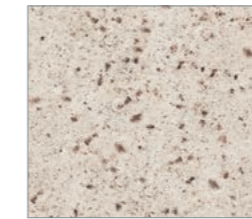

QDI: OYA TUFF STONE

Art 藝術

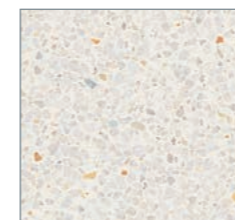

QZW: TERRAZZO WHITE

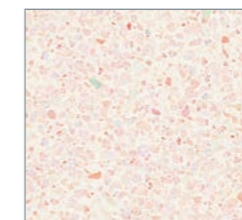

QZP: TERRAZZO PINK



IMV: MOSAIC BEIGE



IMG: MOSAIC GRAY



IAG: EMBOSS TILE



QIA: TOY WOOD BLUE



QIP: TOY WOOD PINK

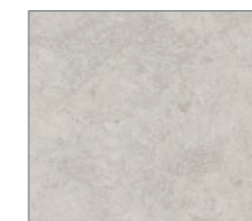

QCG: CONCRETE LIGHT

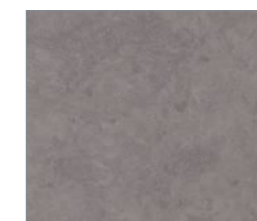

QCQ: CONCRETE DARK

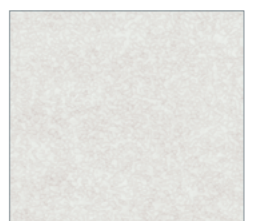

QYW: WHITE PORCELAIN

Enameled Washstand

Let our full-line enameled products help you start your day feeling clean and refreshed.
完全琺瑯，讓一天的開始清清爽爽。



Three unique bowl plans are available to suit your lifestyle.

可根據生活方式選擇3種個性派盥洗盆設計

One-sided bowl plan

偏置盥洗盆設計

Why not do your hair and makeup while sitting on a chair? The counter is spacious and can also serve as a multi-purpose table where you can put your makeup sets or your favorite figurines, objects, etc.

偏置盥洗盆便於用戶坐在椅子上化妝打扮。寬大的化妝台可替代多功能桌，放置喜愛的裝飾擺件和化妝品。



Twin bowl plan

雙盥洗盆設計

To get yourself ready for work or school in a busy morning is a race against the clock. With the twin-bowl plan, you can get yourself ready at your own pace without competing with your family members for the washstand. This is a refreshing way to start your day.

早晨的梳理时间可謂爭分奪秒。如果有兩個盥洗盆，則一家人無需你爭我奪，各選一邊不慌不忙地進行準備，讓美好的一天從心情愉快的早晨開始。



Center bowl plan

中心盥洗盆設計

The basic center bowl plan is a fascinating choice because it can fit a variety of counter widths. A large-capacity wide bowl is also available.

基礎型的中心盥洗盆設計的魅力在於，可滿足各種寬度尺寸。可選擇能夠隨心所欲使用的大容量寬型盥洗盆。



*A wide bowl is not available with a 75cm-wide counter.
*寬度 75 cm 不對應寬型盥洗盆



Quartz stone counter

石英石化妝台

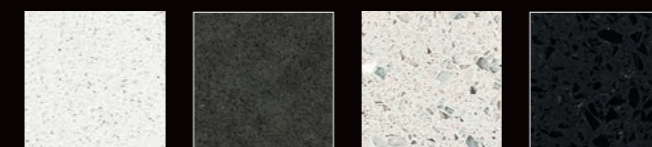

Blanc Sorbet Sandy Haze Jewel Silver Jewel Black

These high-grade artificial stone counters use natural quartz as the main ingredient that expresses the beauty of natural material. Stain and scratch resistant, they keep shining like quartz and stay looking elegantly beautiful for a long time.

以天然水晶(石英)為主要成分，展現天然材料美觀的高級人造石化妝台。耐髒污和損傷，可長久保持如水晶般的光澤和格調高雅的美觀。



Cabinet door colors

儲物櫃門顏色

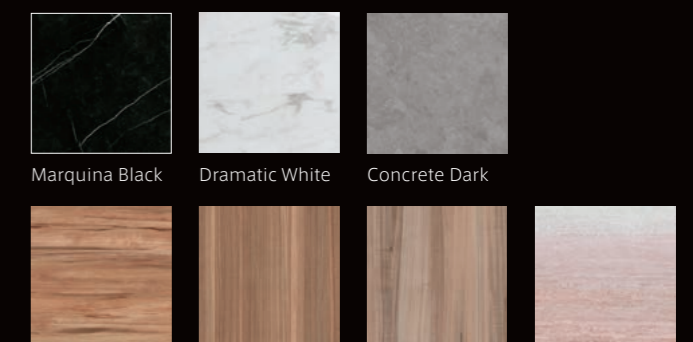

Marquina Black Dramatic White Concrete Dark Spalted Beech Vertical Wood Grayish Marronnier Stone Rose

Popular enameled doors are now available with new inkjet-printed patterns. With much attention paid to nuance and detail, these unique patterns look like real marble. These cabinet doors can transform your hand-washing area into a high-quality relaxing and "healing" space.

深受歡迎的琺瑯門又新增了噴墨圖案。與天然石一般無二的精緻的圖案以及展現細緻韻味的獨特的大理石圖案，將盥洗空間裝點得更加高貴而優雅。



The washstand keeps you and your family clean and should be convenient and functional.

盥洗室是創造美麗的場所，因而需要使用便利且功能齊全。

2-way counter

2WAY化妝台

The Wet area allows you to put items that will get wet (such as hand soaps) while the Dry area is used for items you don't want wet (such as towels). You will likely find these two areas to be highly convenient.

洗手液等液體物品放置在濕區，毛巾等不希望弄濕的物品放置在乾區。2個區域可方便地區分使用。



High-back counter

高背化妝台

There will be no water collected at the base of the faucet. This means that the faucet does not get stained easily. The bowl is integrated with the counter and easy to clean.

水龍頭根部不會積水，因此不易變髒，與盥洗盆整體成型，因而易於進行維護保養。

Touchless faucet

非接觸水龍頭

The faucet can be turned on and off without touching it. It is highly convenient because you can wash your hand while doing makeup. It is highly hygienic because you don't need to touch the faucet when washing your hands after returning home.

無需接觸水龍頭，便可放水或關水，因此，化妝時洗手非常方便。外出回家後，也無需接觸水龍頭，潔淨衛生。



Enameled cabinet

琺瑯儲物櫃

The inside of each cabinet drawer is also enameled and heat-resistant. This means that you can put a curling iron back in place immediately after use. There is no need to wait until the hot curling iron to cool down.

儲物櫃的收納也採用非常耐熱的琺瑯製成，因此，燙髮剪可在高溫的狀態下直接收納，而省去花費時間使其冷卻的麻煩。



Magnetic storage holder

磁鐵收納

The cabinet doors are enameled so that magnetic storage holders (such as a towel hanger) can be attached to them.

儲物櫃門用琺瑯製成，可佈置磁鐵收納配件，用於掛置毛巾等。

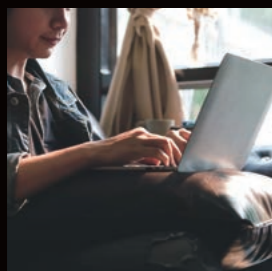

Color Variations 門板顏色選擇

◎Eleena < All 9 colors > < 9 色可選 >

Enamel Washstand 琺瑯洗面化妝櫃

group1 < All 7 colors > < 7 色可選 >



EJQ: MARQUINA BLACK



EJD: DRAMATIC WHITE

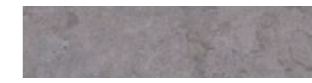

EJC: CONCRATE DARK



E1S: SPALTED BEECH



E1E: VERTICAL WOOD



E1T: GRAYISH MARRONNIER



E1P: STONE ROSE

group2 < All 4 colors > < 4 色可選 >



EXB: ROSE WOOD DARK



EXW: ROSE WOOD WHITE



ECV: SILKY WOOD BEIGE



EPW: PEARL WHITE

◎Famile < All 8 colors > < 8 色可選 >

Enamel Washstand 琺瑯洗面化妝櫃

group1 < All 5 colors > < 5 色可選 >



YWQ: WALNUT BLACK



YWV: WALNUT GRAIGE



YBB: MIX WOOD DARK



YBW: MIX WOOD WHITE



YPI: PEARL IVORY

group2 < All 3 colors > < 3 色可選 >



YSF: LIGHT GRAY



YST: BEIGE



YSW: WHITE

◎Ondine < All 7 colors > < 7 色可選 >

Enamel Washstand 琺瑯洗面化妝櫃

group1 < All 2 colors > < 2 色可選 >



UEU: WOODY MEDIUM



UEW: WOODY WHITE

group2 < All 5 colors > < 5 色可選 >



UST: BEIGE



USW: WHITE



USP: PURE PINK



USB: BROWN



USF: LIGHT GRAY

Enameled Washstand 琺瑯洗面化妝櫃

Entirely enameled cabinet 完全琺瑯櫥櫃

High-grade enamel is used in every part of the cabinet. This allows the cabinet to be easy to clean and stay clean. 櫥櫃的每一個部分均使用高品位琺瑯，因而保養簡單，始終保持清潔。

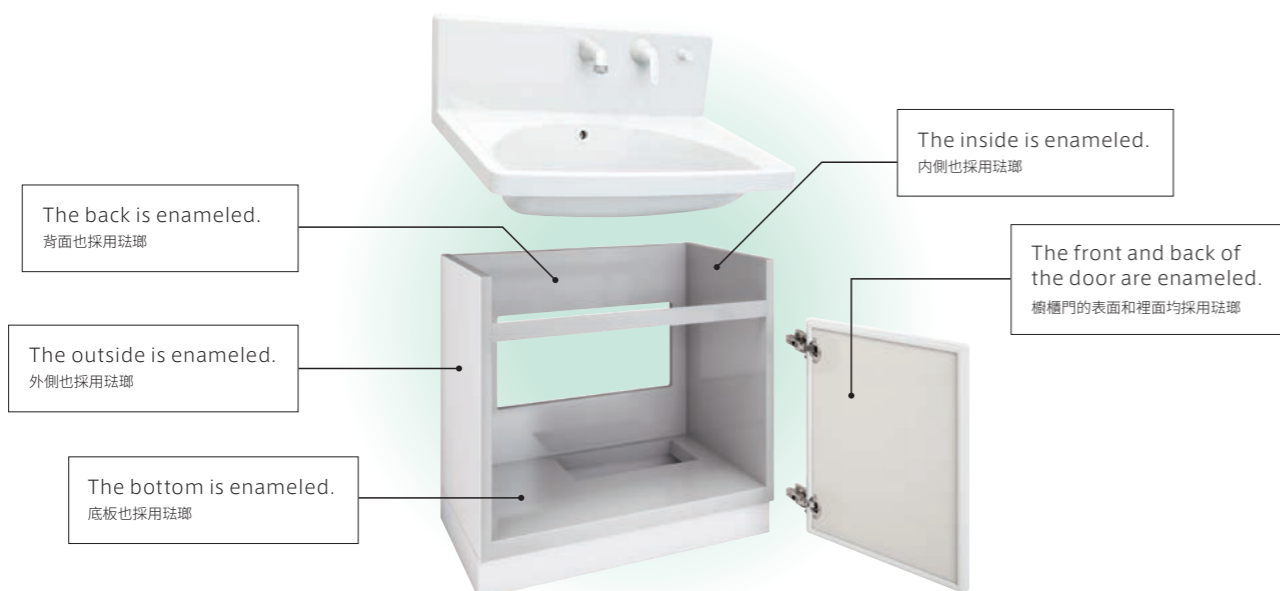

Dirt can be wiped clean quickly with a damp cloth! 即使變髒，也只需清水輕鬆擦拭去除!



Spilled detergent does not penetrate! 即使洗滌劑潑灑出，也不會滲入! *Not applicable to some drawers. ※部分抽屜未對應。

Quartz stone counter 石英岩檯面



Counter color 檯面顏色

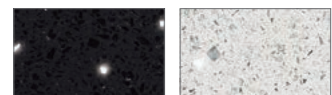

Bowl (Acrylic artificial marble stone) 洗面台 (壓克力人造大理石)



Acrylic artificial marble stone counter 壓克力人造大理石檯面



Color 顏色



Mirror

Face clear mirror 高亮度鏡

75 · 90 · 100 · 120 · 135 · 150 · 165cm

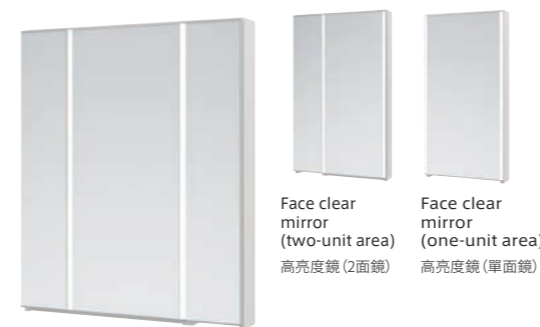

Face clear mirror (three-unit area) 高亮度鏡 (3面鏡)

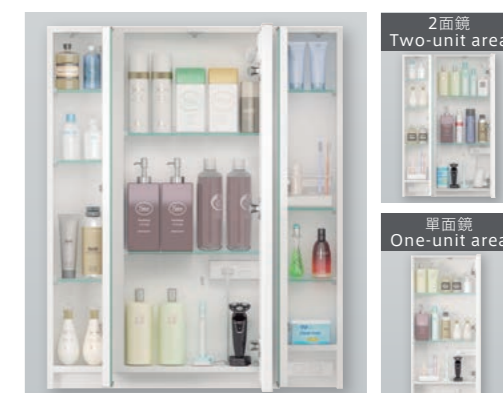
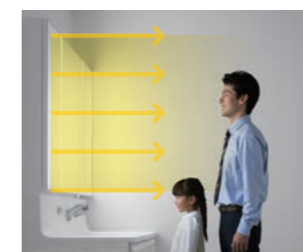

Stylish Triple Mirror (LED specification) 三面鏡時尚設計 (LED規格)

75 · 90cm



The user's face looks dark because the shadow appears on the face. 臉色偏暗。



A wide range of the LED illumination allows for the face brighter. The high color-rendering LED light makes the face to look more natural. 因為採用高性能的LED燈，不只燈光的照射範圍擴大而且光源更趨近自然光，臉部氣色更加自然。



Behind-the-mirror storage 鏡背收納

Slide storage 鏡子下方有抽屜收納

Triple mirror 三面鏡【wideLED 大寬LED】

75 · 90 · 100 · 120cm



Triple mirror 三面鏡

75cm



60cm Double mirror 二面鏡

60cm



Single mirror with storage space 單面鏡(附鏡箱)

60 · 75cm



Single wide mirror 單面大型鏡

75 · 90 · 100 · 120 · 135 · 150 · 165cm



Single mirror 單面鏡

60 · 75cm



System Bathroom

Provides long-lasting cleanliness while keeping you warm.
潔淨、溫暖、恆久不變。

 **PREDENCIA**













Bathroom Panel 浴室面板

Enamel Clean Bathroom Panel 珐瑯清潔浴室面板

Wall panels are enameled and can stay clean for a long time. The vitreous surface material makes cleaning easy and prevents dirt penetration, keeping its beautiful gloss for many years.

牆壁面採用珐瑯，故而潔淨持久的“珐瑯清潔浴室面板”。表面為玻璃質，因而保養簡單，污垢不會滲入，永保美麗光澤。



Scale is wiped off quickly with a damp cloth. Scratch-resistant and durable enough to be scrubbed hard with a brush. High-grade enamel panels are used to keep cleanliness easily and clean easily.

即使黏附水垢，也只需清水擦拭便可輕鬆去除。因為不易劃傷，因而即便用刷子刷洗，也不必擔心。面板使用高品位珐瑯，追求能夠輕鬆保持潔淨，易於清掃的特性。

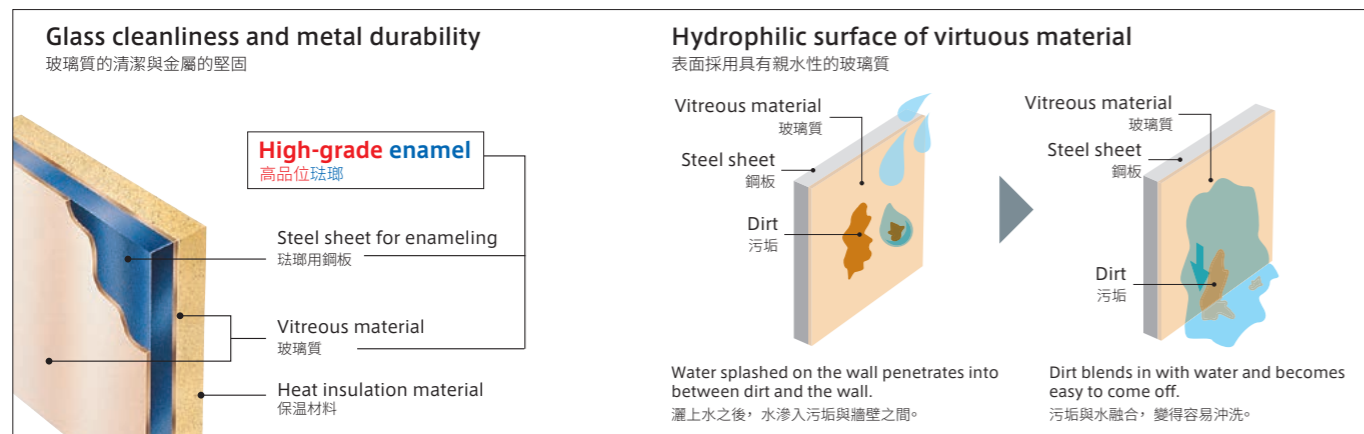

*The thickness shown in the picture is for reference purposes only. ※厚度為示意。



Magnets can be used conveniently as the base is metallic.
底板為金屬，因而可用磁鐵吸附，使用方便。



Bathroom floor 浴室地板

Keep Clean Floor 保潔地板

“Keep Clean Floor”, durable and scratch-resistant, makes it easy to remove dirt. The large 30cm square porcelain tiles, which have a beautiful, texture like natural stone, prevent dirt penetration and keep their beauty.

浴室地面採用結實不易劃傷，而污垢容易去除的“保潔地板”。30cm正方的大塊瓷磚，具有天然石一般的風格，污垢不會滲入，可永保美觀。

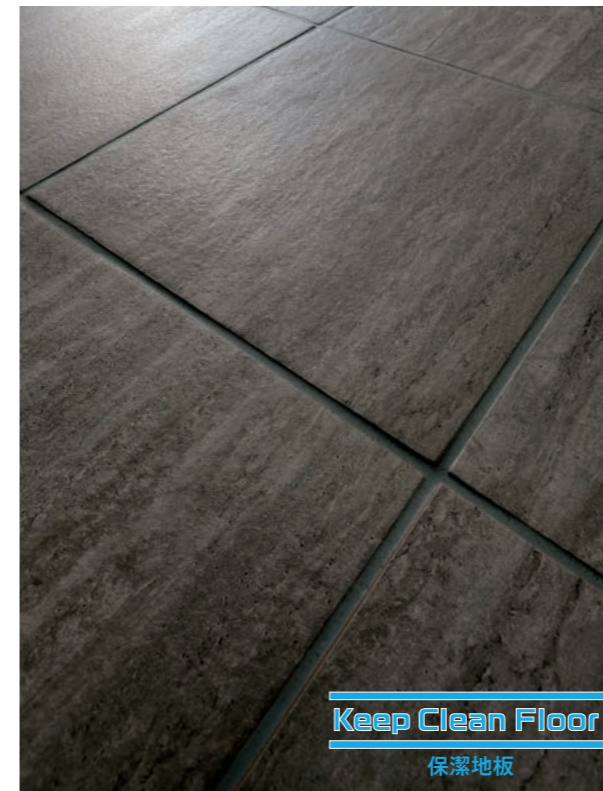

It prevents dirt penetration, thereby keeping it clean indefinitely.

結實且污垢不會滲入，因而能保潔淨。



After use of long period
即便長年使用

Porcelain tile part
瓷磚部分

Scratch-resistant, prevents dirt penetration.
不易劃傷，污垢不會滲入。



After use of long period
長年使用之後

Scratch 傷痕
Dirt 污垢

Difficult to remove dirt accumulated in scratches.
污垢滲入傷痕，難以去除。

Easy-to-detach hair catcher 拆裝簡便的頭髮濾網

Remove the hair catcher by holding the large tab and take out hair from it.

較大的凸爪便於輕鬆取下，清除濾網上的髮絲。



The floor has a durable, 4-layer structure that prevents bending due to long-term use.

地板採用結實的4層結構，能夠防止因長年使用而導致彎曲。

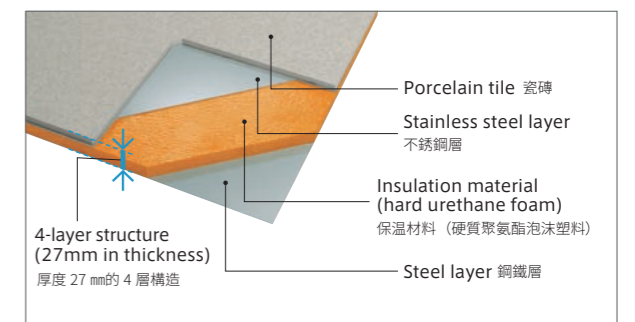

Takara's commitment is also focused on enhancing durability and safety. The frame-structured stand firmly supports the weight of the bathroom, making it possible to withstand vibrations equivalent to a seismic intensity of 6.

TAKARA 還專注於追求堅固性·提高安全性·穩固支撐浴室重量的框架構造的架台，可抗禦相當於震度 6 級規模的振動。



Bathtub 浴缸

Enameled Cast Iron Bathtub 鑄件琺瑯浴缸

A thick glass layer finished by skilled workers provides a comfortable gloss and texture of genuine glass. An advantage is scratch-resistant against daily cleaning due to the high surface hardness. Dirt is hard to adhere and can be cleaned immediately if adhered.

由熟練的匠人加工製成的厚實玻璃層，讓您能真正感受到玻璃特有的光澤和質感。表面硬度較高，擁有不會因日常保養而受損的優點。不易黏附污垢，即使黏附也可立即去除。

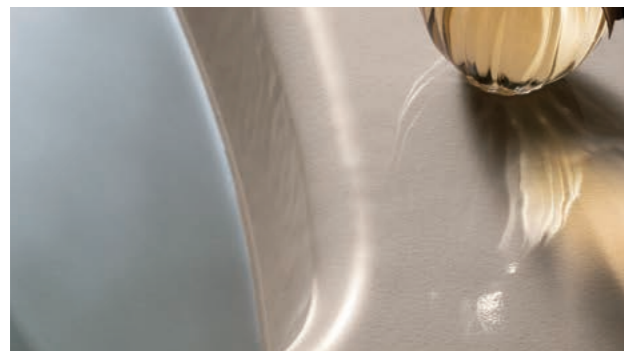

[Applicable series] PREDECIA
[對應系列] PREDECIA

The everlasting smoothness allows dirt to be removed easily.

永保順滑，即使黏附污垢，也可輕鬆去除。

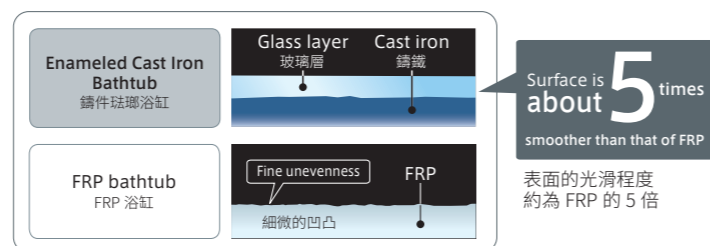

Keep Clean Bathtub 保潔浴缸

Keep Clean Bathtub is made of an excellent material that removes dirt easily and keeps the surface clean. Its surface smoothness is about 3 times that of FRP. This makes daily cleaning much easier.

保潔浴缸是由優越性佳的材質所製成，表面光滑程度是 FRP 的 3 倍，污垢易於清除得以維持光滑潔淨的表面。日常保養非常輕鬆。



[Applicable series] RELAGE
[對應系列] RELAGE

The smooth surface allows dirt to be removed easily and keeps its cleanliness.

表面光滑，因而污垢容易去除，保持潔淨。

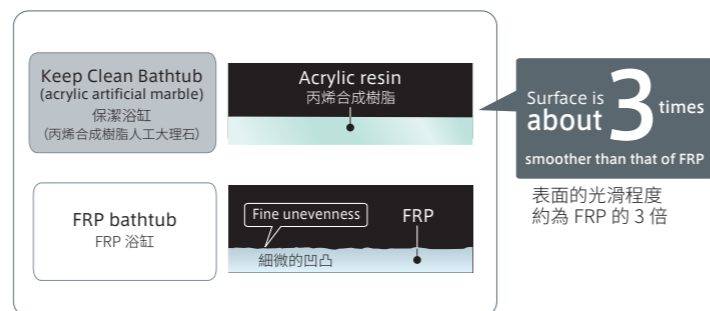

Perfect Fit Bathtub 恰好尺寸整體衛浴

The bathtub can be made to order in size in small increments of 2.5 cm, which makes it possible to create a spacious bathroom with a maximum use of the original bathroom space in the building. This allows it to flexibly respond to various space and size restrictions.

尺寸可以 2.5cm 為一檔任意選擇，實現最大限度地利用建築物本身的浴室空間的寬敞浴室。不僅是寬敞程度，還可靈活應對各種空間制約。



※The applicable size depends on the series.
※可對應的尺寸根據產品系列而有所不同。

Excellent heat retention 保溫性能

The "Perfect Insulation" material provides the whole bathroom with perfect protection against cold using insulation material for the entire bathroom.

Takara Standard's unique "Perfect Insulation" is employed to surround the bathroom with extra-thick heat insulating panels, keeping the inside of the bathroom warm even on cold winter days. This feature comes standard for most of the Takara Standard's bathrooms, making them very popular among customers.

Takara standard 獨創的「完美保溫」，透過對浴室所有面施以較厚的保溫材料等，即使在冬季，也能夠充分保持溫暖。幾乎所有浴室均標準配備，這也是獲得好評的關鍵之處。



●The orange color in the figure is for illustration purposes only.
●保溫材料的顏色（橙色）為示意。

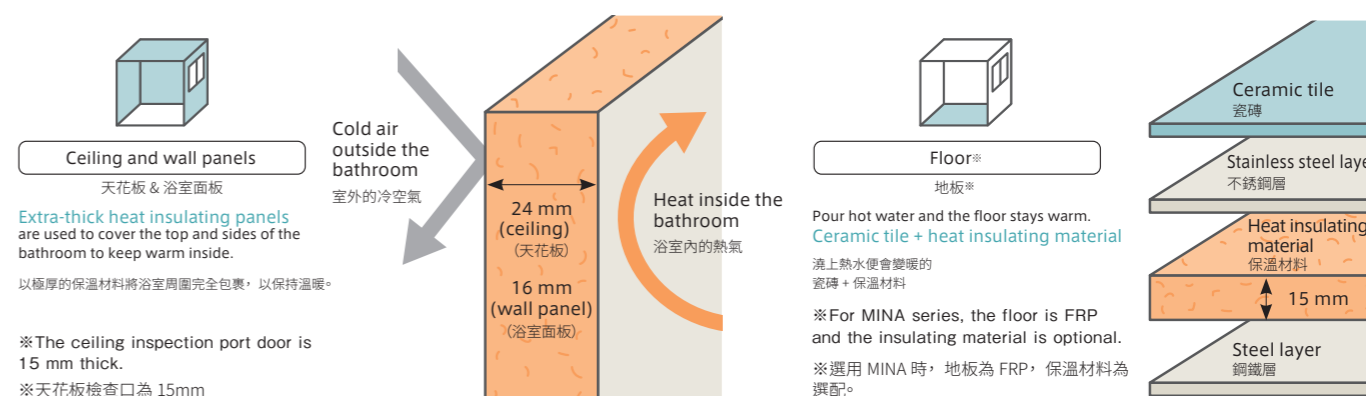

Shower Unit

The industry's only made-to-order shower unit matches your required size perfectly.

是業界唯一可按用戶的要求，選擇尺寸的整體淋浴間。



Perfect Fit Shower Unit 恰好尺寸淋浴間

Offers about 2,000 size variations ranging from the industry's smallest to the largest ones. This shower unit can flexibly fit in a long or wide room in various sizes, which can meet a variety of installation conditions.

從業界最小級別到最大級別，可對應約2,000種豐富的尺寸變化。尺寸自由選擇，可對應縱長形，也可對應橫長形，對於多種多樣的設置條件也完全吻合。

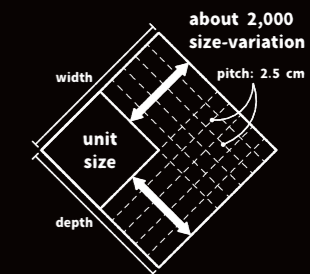

Easy to clean 易於清掃

Designed to be stain-resistant and easy to clean, the shower unit features the "Keep Clean Floor" that is sturdy, scratch-resistant, and easy to clean and the "Keep Clean Door" that provides excellent resistance to stain. These features always keep your shower room clean.

充分採用結實而不易損傷、污垢容易去除的“保潔地板”，以及不易堆積污垢的“保潔門”等，不易髒污、容易保養的構件。可使淋浴間始終保持光潔。

High heat retention properties 高保溫性能

The "Perfect Heat Insulation" panels cover the ceiling, walls, and floor of the shower room, which keeps you warm while taking a shower.

將天花板、牆壁及地板用保溫材料完全包覆，實現持續保溫的“完美保溫”。可使淋浴間始終保持溫暖舒適。



The process of creating high-grade enamel that strongly supports housework

家務的好幫手——高品位琺瑯的誕生過程

“Takara standard delivers good products.”

That is the mission of our factories.

We use our own technologies in each manufacturing process to produce strong and beautiful high-quality enamel.

“將優質產品交到用戶手中。”這是Takara standard的工廠的使命。

在每一步製造工序之中，充分發揮獨有技術，創造出堅固而美觀的高品位琺瑯。

1 Steel sheet processing 鋼板加工

Metal sheets, called steel sheets, are processed according to applications and welded by robots. For steel sheets with complicated shapes, it is difficult for robots to process them, so experienced workers will perform the work manually.

將被稱為鋼板的金屬板，根據用途進行加工，利用機械手進行焊接。複雜的形狀用機械手難以應對之時，由經驗豐富的匠人以手工作業進行加工。

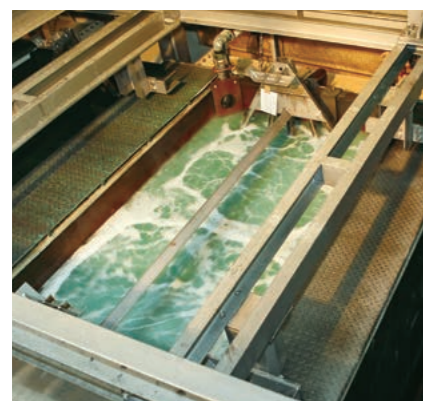

2 Preprocessing 前處理

To enhance the adhesion between the steel sheets and glaze, the steel sheets are dipped in sulfuric acid to make the surfaces finely uneven, and nickel is processed for adhering it to the steel sheets, and so on.

為了提高鋼板與釉料的接合力，施以將鋼板浸泡在硫酸之中，使其表面出現細微的凹凸狀，以及使鎳附著在鋼板上等處理。

3 Glaze manufacturing 釉料製造

The constituents of the glaze, such as silica and feldspar, are formulated and mixed at an appropriate ratio. After the constituents are fused at 1200 to 1300°C, they are cooled and hardened to form frits. Clay, water, and various other chemicals are added to the frits, which are then finely milled to form muddy glaze.

將作為釉料原料的二氧化矽及長石等，以適當的比例進行調配及混合。以1200~1300度熔融之後，再使其冷卻凝固，形成玻璃料。然後加入黏土、水及各種藥品等，細細粉碎製成泥狀釉料。



What is the enamel made of?

琺瑯是這樣的材料。

Enamel is made by spraying glassy glaze on the surface of metals such as iron and aluminum and baking the metal at a high temperature.

向鐵、鋁等金屬表面，噴塗玻璃質的釉料，再以高溫燒結形成的產品稱為琺瑯。

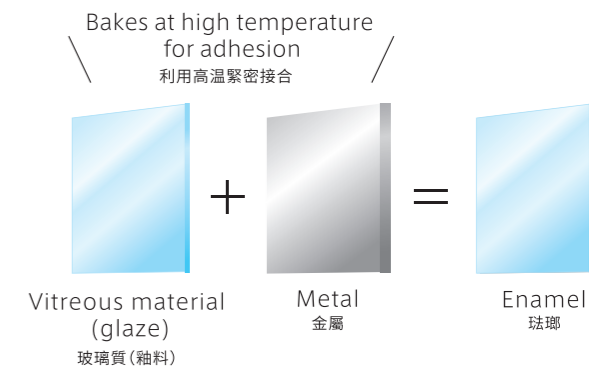

4 Glaze application 上釉

The glaze is sprayed evenly and uniformly on the pretreated steel sheets. There are a variety of glaze application methods, such as “electrostatic coating”, “spray method”, and “dipping” that is directly dipped in the glaze. We select the best method, depending on the shape and size of the parts of the products.

向經過前處理的鋼板，均勻地附上釉料。根據部件的形狀和大小，分別採用“靜電塗裝”、“噴塗方式”、直接浸泡在釉料中的“浸漬塗佈”等各種方式。



5 Glaze baking 煨燒

The finely milled glaze is baked in a baking furnace at about 850°C. When melt, the glaze grows crystals and develops colors, forming enamel with a smooth glassy surface.

在約850度的煨燒爐中進行燒結。將研磨粉碎的玻璃融化，使玻璃內結晶成長，產生顏色，製造出具有光滑玻璃面的琺瑯。

6 Finish processing 完成

After baking, each part of the products is strictly inspected: enamel thickness checking and color difference measurement. After they are assembled and cut according to applications, they are finished. After inspection and packaging are complete, they are shipped out.

對燒成的各部件，進行琺瑯膜厚核對、色差計測等嚴格的檢查。根據用途進行拼接和切割，製成完成品。之後，經過檢驗和包裝後出貨。



Some items do not correspond to the items listed in the catalog.

Notices before purchasing

Be sure to read the following before purchasing.

[Stainless sink / Stainless steel worktop]

- Chlorine detergents (bleaches, pipe cleaners, etc.) may cause rust. Rinse thoroughly with water after use.
- Do not use chlorine type slime removers. They may cause rust of metal such as stainless steel or may deteriorate rubber or resin.
- Dragging along the surfaces of the sink/worktop the dishes, hard objects, the kitchen buckets or pots to which sand or mud are adhered, may cause scratches.
- Wipe off ingredients with high salt concentration (soy sauce, miso, etc.) adhering to the products. Leaving them adhered can cause rust.
- Do not leave wet kitchen knives or metal products (canned foods, iron products, or aluminum products, etc.) on the sink/worktop for a long time. Electrical reaction with aluminum, iron, and stainless steel may cause discoloration or rust.
- If rust or rust stains are severe, remove them by rubbing with a cream cleanser in a certain direction.
- Do not leave water splashes in the sink for a long time. Water scale may develop due to their calcium containing ingredients. Wipe them off with a cloth after use.

[Quartz stone worktop / Artificial marble worktop / Artificial marble sink]

- Since fry pans or oil pots become very hot after cooking, do not place them onto the worktop/sink directly after cooking. Cracks, discoloration, deformation (warpage) may occur. Be sure to use a pan coaster. (Note that some pan coasters may convey heat.)
- Dragging along the surfaces of the sink/worktop the dishes, hard objects, the kitchen buckets or pots to which sand or mud are adhered, may cause scratches.
- Some L-types or custom-ordered products may have joints on their worktops.

[Door / End panel / Cabinet]

- Despite the door, end panel, hood front panel and kitchen panel in the same color, variations in their colors or patterns may occur.
- Do not put a wet cloth, etc. on the door of the wooden kitchen or the end panel, or leave water drops or water spills as they are. The surface of wooden entrance may swell, or facing materials may warp, or surface materials may peel.
- Packings attached to the cabinet and door aim to relieve shock when the door is closed. They do not prevent intrusion of animals and pests.
- Enamel members has partially spots that look black such as hanging traces formed by hangers when the materials were hung or marks caused by placing the materials during manufacturing process, but having no problems on the quality.
- Since enamel members are potteries, small black spots caused on the manufacturing process may appear, but there are no problems on the quality.
- Some types of oil/water pens used to write on the products may be time-consuming to clean out depending on the time past after use. In that case, wipe them out with melamine sponges.

- The casters fitted to the storage wagon may leave their traces on some types of floors.

[Range hood]

- The range hood cannot inhale sufficient oil smoke due to the wind direction of air conditioning, the ventilation system etc.
- Some IH cooking heaters cannot inhale oil smoke when installed in an open environment with little ascending air current.

[Faucets / Water purifier /Alkali ion water generator]

- Since the products are used in general households, use them only with tap water. Using hot spring water or well water (groundwater) may cause product failures due to generation of scales (chlorine component), etc.
- Check the capability of the water heaters carefully before installation. Too small outflow of water from the shower will prevent comfortable use of shower. Check the minimum necessary water pressure and maximum water pressure before using.
- Because the combination faucets undergo a large water flow resistance, the amount of hot water may become insufficient, or hot and cold water cannot be mixed smoothly, depending on the type and water pressure conditions of waterers.
- In cold climates, use the products designed for cold districts. (However, they do not prevent from freezing. If freezing may occur, perform drain work in accordance with the instruction manual.)
- The water generator is not designed for cold districts, do not install it in places where freezing may occur.
- For safe and comfortable use of the water faucet fittings, read the instruction manual well after purchasing and perform the inspection and parts replacement regularly.
- ※ Inspect the sink area for water leakage regularly more than twice a year.
- ※ Inspect the invisible part (especially the inside of cabinet) closely.
- ※ Since the packing and the shower hose are consumable/wear parts, replace them periodically.
- Install the faucet with water purification function in a place where water runs once every two-three days.
- ※ The faucet, if not used for more than two days, must be passed purified water for more than one minute before use.
- ※ Retained water without residual chlorines is susceptible to bacterial growth. This may impair physical conditions.
- The water outflow openings of faucet fittings are each placed at different positions depending on the combination of faucet and sink. Contact our office for details.

部分項目與本目錄刊載商品無關。

購買前須知

購買前請務必詳閱。

[不鏽鋼製水槽、不鏽鋼製檯面]

- 含氯清潔劑 (漂白水、水管疏通劑等) 可能會導致生鏽。使用之後請用清水充分沖洗。
- 請勿使用含氯的去汙劑, 以免不鏽鋼等金屬部分生鏽、橡膠或塑膠劣化。
- 拖拽食器或硬物、沾有泥沙的水盆或鍋具可能會造成刮痕。
- 殘留含鹽分較多的食品 (醬油、味噌等) 會導致生鏽, 請擦拭乾淨。
- 請勿長時間放置沾濕的菜刀或罐頭類等的金屬產品 (鐵製品、錫製品等)。錫、鐵和不鏽鋼會產生電化腐蝕導致變色或生鏽。
- 接觸銹或生鏽嚴重時, 請用去汙劑同方向研磨。
- 長時間放置灑落在水槽中的水, 會因碳酸鈣導致附著水垢。水槽使用後請用布擦拭水滴。

[石英石檯面、人造大理石檯面、人造大理石水槽]

- 烹飪後的平底鍋或油鍋等因為溫度非常高, 所以請勿直接放置。否則會導致出現裂痕、變色、變形 (翹起)。請務必鋪上鍋墊等。(依鍋墊材質, 可能會導熱, 請小心)。
- 拖拽食器或硬物、沾有泥沙的水盆或鍋具可能會造成刮痕。
- L型廚房, 台面可能會看到接縫。

[門板、側板、櫃體]

- 門板和側板、抽油煙機罩前面板及廚房用壁板等即使相同色系, 顏色及花紋也可能會有所差距。
- 木製廚房門板或側板處請勿掛置濕毛巾等, 也不要置水滴或溢出的水。否則會導致木切口突起、木材翹起、表面木材剝落。
- 櫃體及門板附有的膠條是為了緩和開門時的衝擊。並非防止動物或害蟲的入侵。
- 珐瑯部件在燒製時, 會留有暗黑的吊鉤吊痕及置痕等, 但不存在品質問題。
- 珐瑯部件是燒製而成, 所以在製程中可能會產生小黑點, 但不存在品質問題。
- 使用油性筆、水性筆時, 因筆的種類或放置時間, 可能需要花費時間擦拭乾淨。此時, 請使用三聚氰胺海綿去除。
- 收納櫃附有滾輪, 所以依地板種類, 可能會有滾輪痕跡留下。

[抽油煙機]

- 依空調等的風向及換氣系統等, 可能會導致不易吸入油煙。
- IH調理爐因為不太會產生上升氣流等, 所以開放空間有可能較難吸入油煙。

[水龍頭、淨水器、鹼性離子整水器]

- 因為是用於一般家庭, 所以僅能使用自來水。若要使用溫泉水或井水(地下水)時, 因會產生水垢(石灰質)而導致產品發生故障。
- 安裝時請充分確認熱水器的規格。淋浴的出水量可能會變少, 導致無法暢快地使用淋浴。請確認必要的最低水壓及最高水壓後再使用。
- 冷熱混合水龍頭的通水阻力較大, 所以依熱水機器的種類及水壓條件, 可能無法獲得充分的熱水量, 或無法順利混合冷熱水。
- 寒冷地區請使用寒冷地區規格的產品(寒冷地區規格並非防止結凍。若擔心結凍, 則請按照操作說明書, 進行排水作業)。
- 整水器並非是寒冷地區規格, 所以請勿設置在可能會結凍的地方。
- 為了使水龍頭金屬配件能夠長期安全而舒適地使用, 購買後請詳細閱讀操作說明書, 進行定期點檢及更換零件。
 - ※關於定期點檢, 請每年兩次以上點檢用水處是否漏水。
 - ※請特別注意看不見的部份(櫃內)。
 - ※因為膠條及淋浴軟管等為會磨損劣化的零件, 所以請定期更換。
- 有淨水功能的水龍頭, 請設置於兩三天可通水一次的地方。
 - ※兩天以上沒有使用時, 請放流1分鐘以上之後再使用淨水。
 - ※殘留水因去除了所殘留的氯, 所以很容易繁殖細菌, 恐會損害健康。
- 關於水龍頭金屬配件的出水口位置, 依水龍頭與水槽的組合而會有所不同。詳細位置請洽詢本公司營業處。

Company Profile 公司簡介

Takara Standard takes responsibility for guaranteeing quality and product supply as a manufacturer, ensured by an extensive production and distribution system.

Takara Standard認為,維持品質與製品供給的穩定是製造廠的責任,因此致力於整頓生產,物流體制。



Head Office/Osaka Factory 總公司,大阪工廠

Factories, Distribution Centers and Affiliates 工廠,物流中心以及相關公司

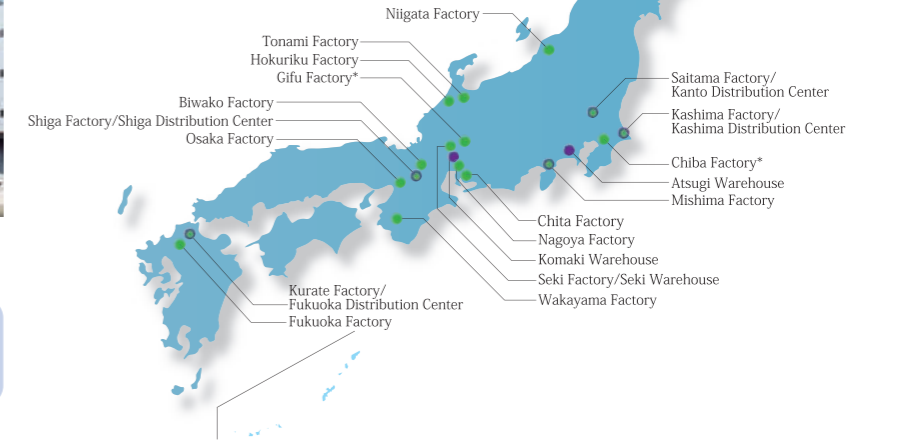

Showroom 展示中心

Approximately 160 showrooms around Japan, the most in the industry, and a broad-based training system combine to provide a strong base for sales.

在日本國內約有160間展示中心,擁有業界最多的銷售點,充實的進修制度,提升整體銷售素質。

Company History 沿革

- 1909 Kitahata Factory established as Japan's first enameled ironware factory. 北早田廠成立,是日本最早的漆包線五金廠。
- 1912 Nippon Enamel Co., Ltd., incorporated. 設立「日本Enamel株式會社」。
- 1945 Manufacture of enameled ironware for home use begun. 開始製造家庭用珐瑯鐵器。
- 1957 Japan's first stainless steel sink press developed. 日本最早以衝壓加工法成功製造不鏽鋼水槽。
- 1962 World first enameled kitchen developed. 成功開發出全世界最早的珐瑯廚房。
- 1971 Company renamed TAKARA STANDARD CO.,LTD. 公司名稱改為「Takara Standard株式會社」。
- 1973 Company listed on First Section of Tokyo Stock Exchange. 於東京證券交易所第一部上櫃。
- 1977 Distribution of enameled kitchens begun. 開始生產珐瑯廚具。
- 1986 Distribution of enameled system kitchens begun. 開始生產珐瑯系統廚具。
- 1991 Achieve the sales of 100 billions yen. 營業額 日幣1000億 達成。
- 1992 Released the enamel kitchen panels 開始銷售珐瑯廚房面板
- 2012 100th anniversary since establishment. 公司創立100周年。
- 2016 Successfully developed the enamel inkjet printing technology 成功開發珐瑯噴墨技術
- 2022 Celebrated the 110th anniversary of its foundation 創立110週年

